



HOSHIZAKI EUROPE

HOSHIZAKI SERVICE MANUAL

BAKER M & F 550



**As the user, please use the operating instructions.
This service manual does not include operating instructions.
It is only intended for the service technician.
here.**



Content

1) Safety Information	3
2) Intended Use.....	3
3) Suitable Installation Site	3
4) Setting up Several Cabinets Side by Side	5
5) Unpacking and Installing the Cabinet	6
6) Condensation Water Re-evaporation.....	8
7) Electrical Connection.....	8
8) Instructions for Daily Use.....	9
9) Cleaning and Maintenance	10
10) Control Elements.....	12
11) Switching the Door Hinge Side.....	24
12) Removing and Reattaching the Evaporator Cover	27
13) Measures for Taking the Cabinet out of Operation for Long Periods.....	29
14) Disposal	29
15) Technical Support and Ordering Spare Parts	30
16) Technical Data	31
17) Dimensions	32
18) Wiring Diagram.....	33
19) Cooling Diagram.....	35



1) Safety Information

This service manual does not include comprehensive operating instructions for the user; it is only a further supplement to the operating instructions.

It intends for a trained service technician. As a result, many important safety instructions for the user are missing about the scope and readability. In case of doubt, please observe the information in the operating instructions for transport, installation, operation, and electrical safety and never pass on this service manual in place of the operating instructions.

2) Intended Use

This cabinet is intended for the storage of packaged foods at a constant temperature. This cabinet mustn't be used to cool down or freeze foods.

Area of application:

Climate Class	Ambient Temperatures and Humidity
4	+30°C with %55 RH
5	+40°C with %40 RH

3) Suitable Installation Site

The cabinet must be installed in a dry, well-ventilated room away from direct sunlight at a sufficient distance from radiators and other sources of heat. Please always consider the waste heat of all cabinets installed in one room!

The ambient temperature must lie between a minimum of **+16 °C** and a maximum of **+ 40°C**. A gap of at least 50 cm must be kept between the top edge of the machine compartment and the ceiling. The air exchange in this area must not be obstructed from the front or the side by screens etc. hanging from the ceiling.

For electrical safety reasons, the cabinet must not be operated outside. The refrigeration technology of the cabinet does not function outside or in unheated rooms (particularly in colder seasons) and can be damaged by low temperatures.



Distance from walls and ceiling:



A gap of at least 500 mm must be kept between the top edge of the machine compartment and the ceiling, and of at least 50 mm from walls, furniture and other cabinets.

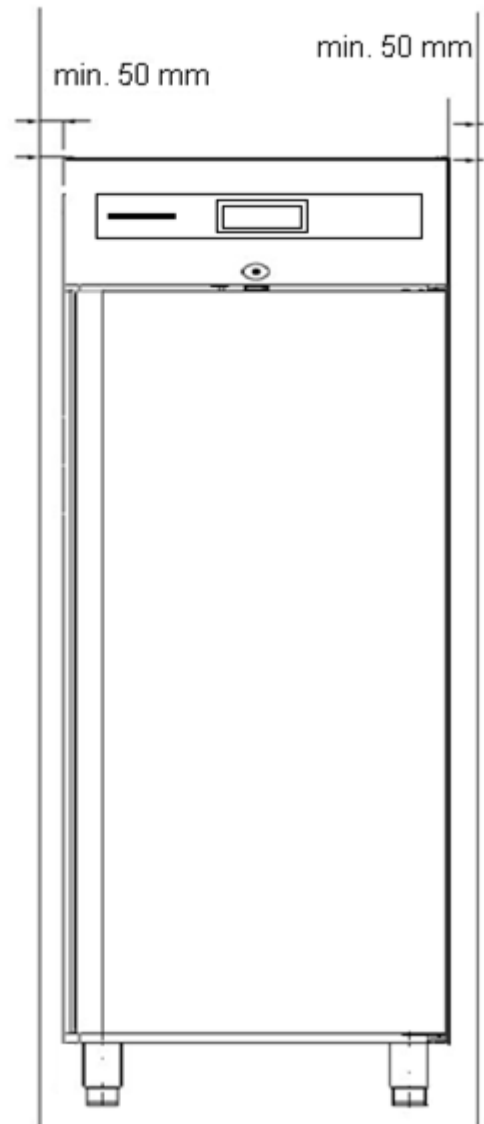
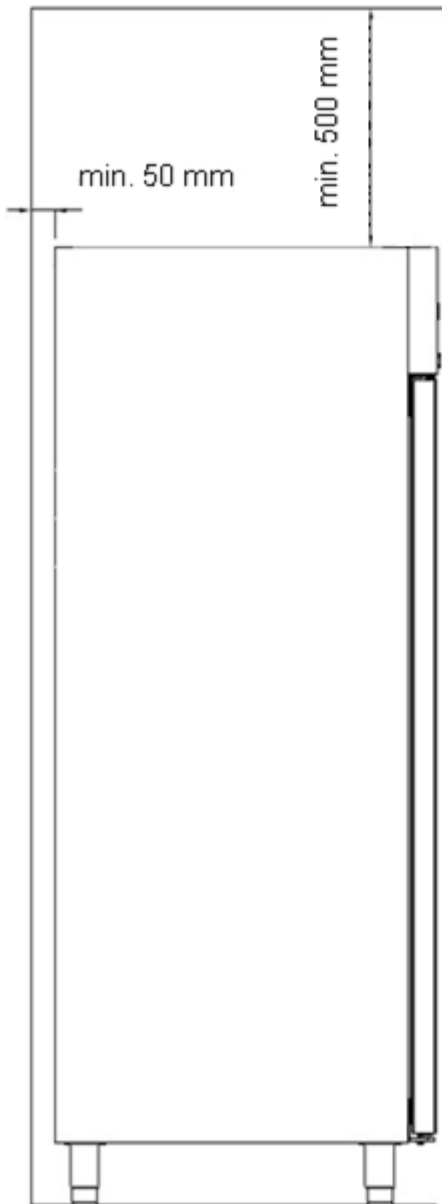



4) Setting up Several Cabinets Side by Side

Depending on the temperature and air humidity at the installation site as well as the selected set point setting, the moisture in the ambient air can condense on the surface of a refrigerating unit due to its design.

If several cooling or refrigeration units are set up side by side, this condensation effect becomes stronger, and a lower air quantity can circulate between the cabinets. As a result, a minimum distance of **30 to 50 mm** must be kept between the cabinets depending on the temperature and air humidity.

These gaps must not be sealed either at the top or bottom, but can be covered by a stainless-steel panel from the front for aesthetic purposes. The panel must be removable for cleaning within the gaps.

If it is not possible for air to circulate freely at the bottom, e.g. due to a base installation, then the gaps cannot be sealed at the front.

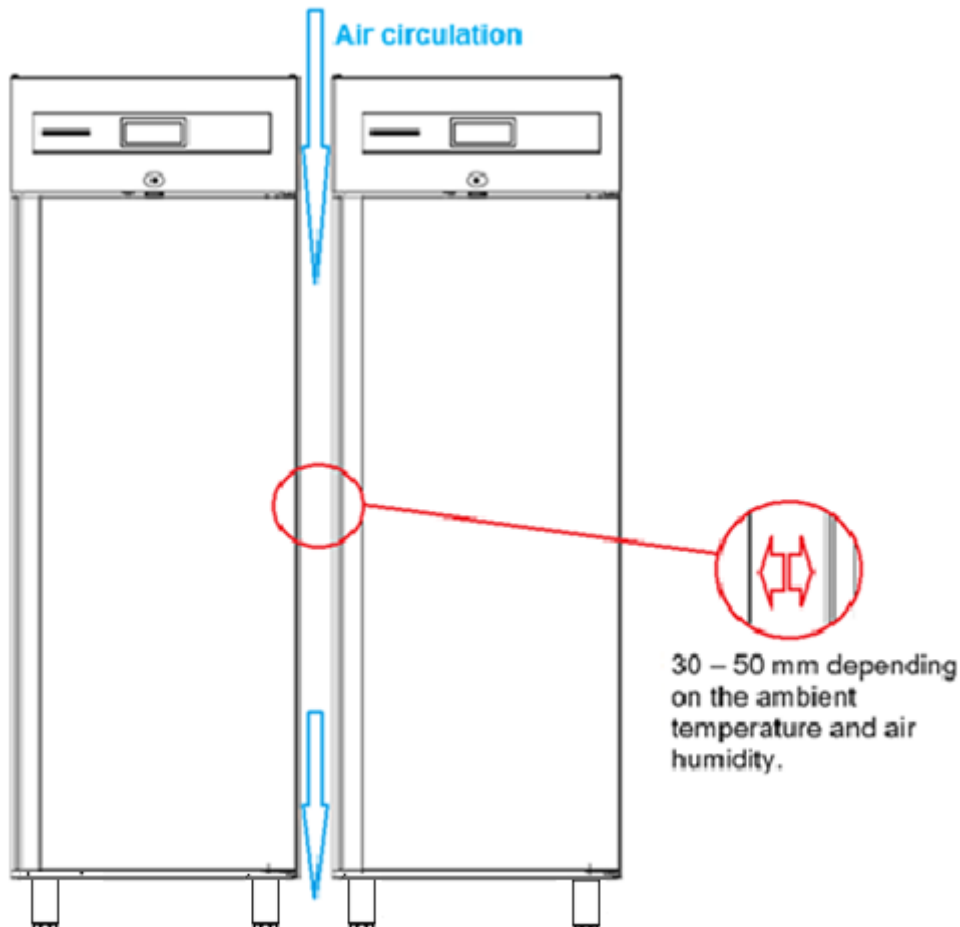



5) Unpacking and Installing the Cabinet



Warning

The refrigeration unit is located at the top of the cabinet. At least two people are required to lay down the cabinet and set it up right again.



Important

If the cabinet has laid on its back or was transported horizontally, then it must stand upright for at least two hours before switching it on to allow the oil to collect in the compressor.

Once the cabinet is on its back, the transport pallet must be removed by the following order;

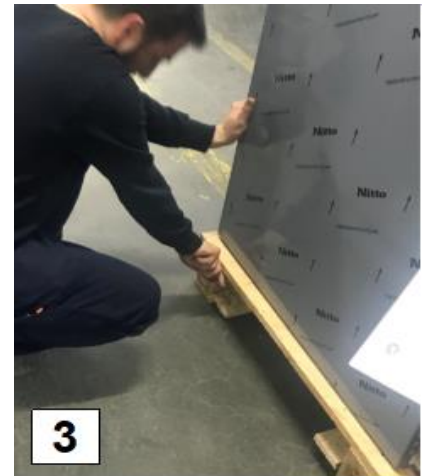
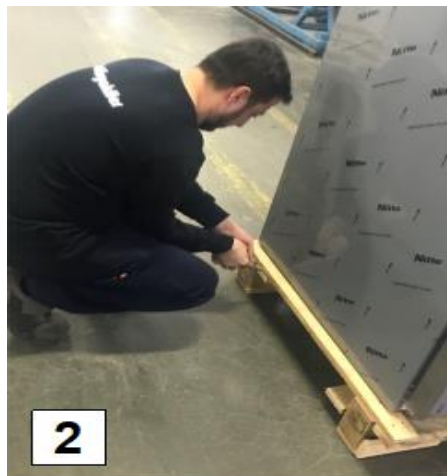
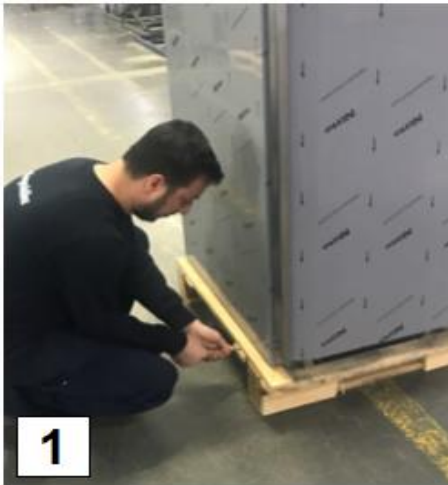

1-2-3) 2 pieces of long wooden pieces at the bottom of the pallet are detached from the lower part of the pallet with the help of a screwdriver from the left side of the refrigerator.



4-5-6) The other side of the long wooden pieces is moved to the right side of the refrigerator and detached from the bottom of the pallet with the help of a screwdriver.

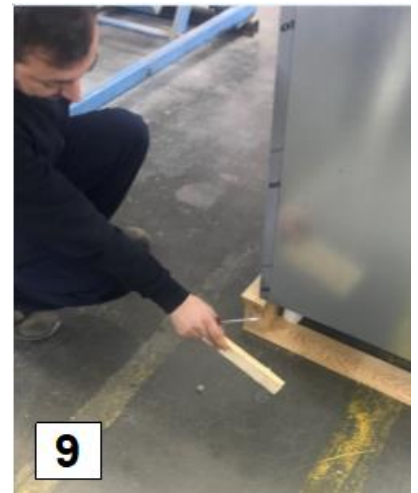
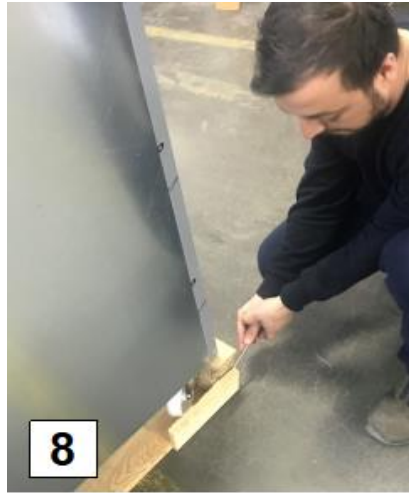
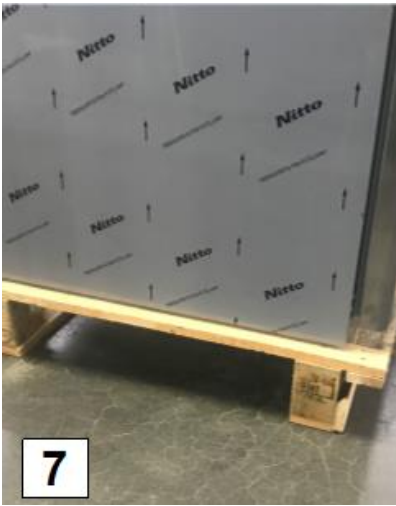

7-8-

9)

Then, 2 pieces of short wooden pieces at the back of the pallet are removed by hand. Once the pieces of wood that hold the cabinet to the pallet are removed, it means the cabinet is no longer connected to the pallet.



10-11-12) With the help of a pallet truck or by means of 2 people, the cabinet is first tilted to one side from the pallet and then the pallet is removed from the bottom.



13-14) After the pallet leaves the refrigerator, the refrigerator is left slowly and with its feet evenly on the floor.



Cabinets on legs:

Cabinets on legs require an even, solid floor. Cabinets on legs are levelled by turning the internal part of the feet.

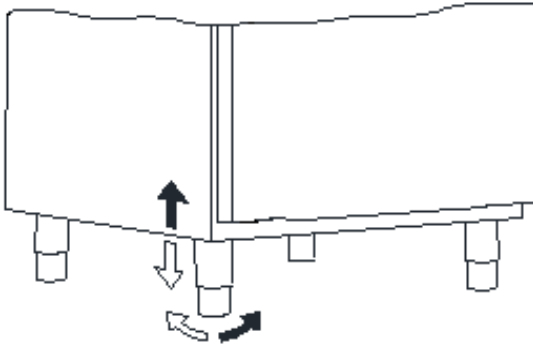

6) Condensation Water Re-evaporation

The cabinets are equipped with a chamber for re-evaporation of the condensation water on top of the cabinets. This equipment is intended for the amount of condensation water that accumulates on average with a maximum of 72 door openings per day according to **ISO 22041**.

The actual amount of condensation water may vary depending on usage and ambient conditions. If the number of door openings per day exceeds 72, or the condensation water pan overflows due to other usage factors, the user must use the product strictly under the specified conditions to prevent overflow. If the amount of condensation increases despite not changing the usage or the ambient conditions, the cabinet may have a defective door seal or a door that does not close properly.

7) Electrical Connection

The 220-230 V/50 Hz mains connection is established by plugging the provided cable with appliance connector into a socket with earthed protective contact.

30 mA residual current circuit breaker is essential.

There may be special regulations from your local energy supply company regarding earthing measures that must be observed.



During working with the electrical equipment, the cabinet must always be disconnected from the mains by pulling out the power plug. It is NOT sufficient to switch off the cabinet with the ON/OFF button as parts of the cabinet are still live



8) Instructions for Daily Use

In order to achieve the necessary air circulation in the interior, only store goods within the corresponding markings (loading marks) and on the shelves (never on the floor or in front of the air outlets).

No electrical cabinets may be operated inside the cabinet.

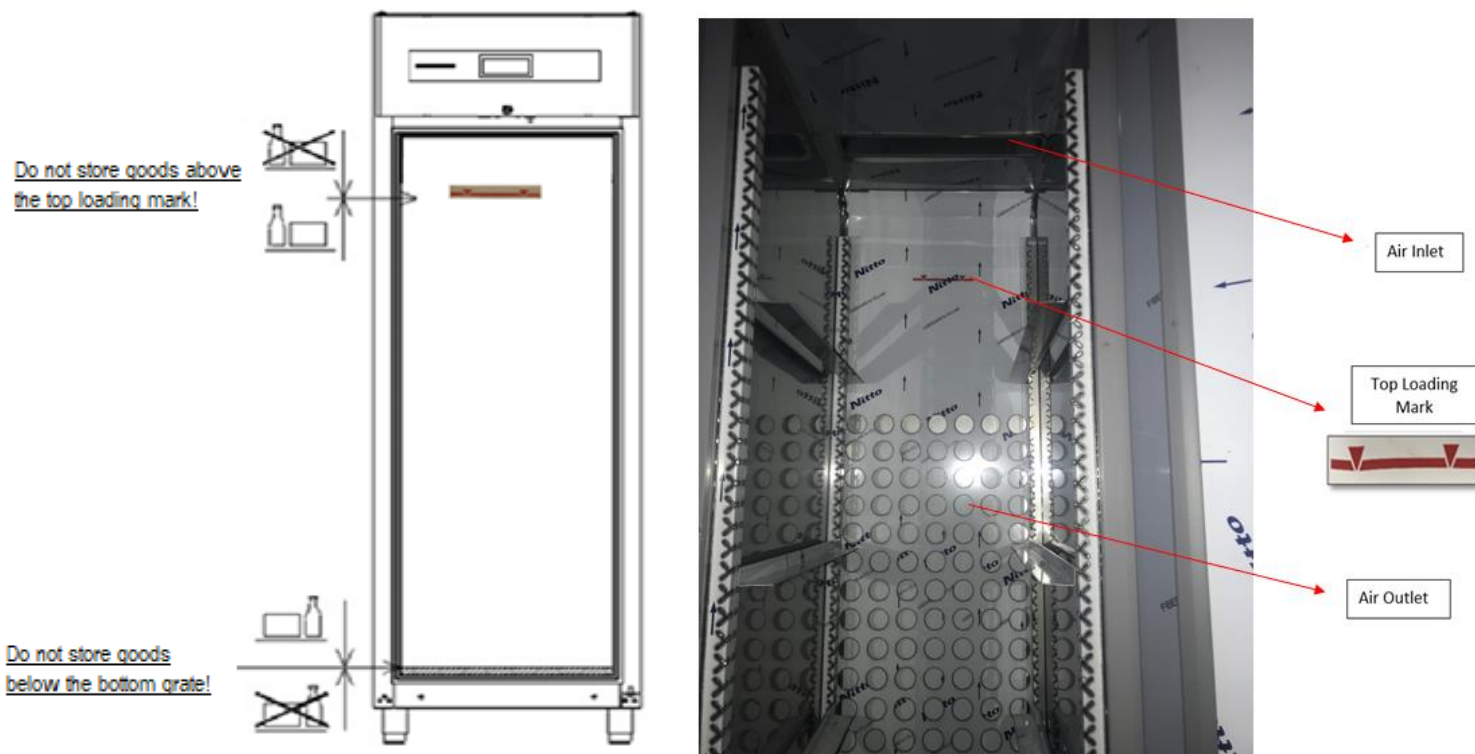



9) Cleaning and Maintenance

The cabinet must be cleaned regularly. The intervals depend on the usage and level of soiling (at least annually).



Before carrying out any cleaning or maintenance operations, unplug the unit



Don't touch or wet the machine compartment parts. This could result in failure or breakdown.



To prevent possible damage, don't clean the plastic parts with water above 40° C or in a dishwasher.

Interior & Exterior of Cabinet and Shelves



Clean the interior and exterior at least once a week for sanitary use.



Clean off the interior and exterior of cabinet with a soft cloth soaked in cold or warm water containing the proper amount of neutral cleaner and wrung dry. Don't use a water jet to clean the machine compartment.



Chemical agents other than neutral cleaner might cause damage to the interior and exterior surfaces.



Any remaining detergent will damage metal or plastic surfaces. Use a soft cloth dampened with warm water to wipe it off.



Don't use the following items, they could damage painted or plastic surfaces:

- Polishing powder, alcohol, thinner, benzene, acidic or alkaline detergent, hot water, petroleum, soap powder, metal scourer or brush, etc. Especially detergent to clean grease on ventilator or microwave

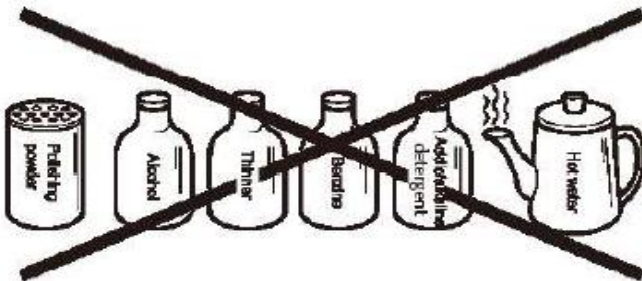

Note: Some solutions other than the above may also damage painted or plastic surfaces. Immediately stop using such solutions if they cause any problems!



The door gasket and its contact surface get soiled easily. Clean every surface of these parts thoroughly. Remnants of food will accelerate aging.



Use a cloth to wipe off any water staying inside the cabinet.



Condenser



Use vacuum cleaner or a soft brush to remove dust and stains from the condenser.



Warning: If users clean the condenser with hard brush, such as dishwasher brush, the coating of condenser may peel off.

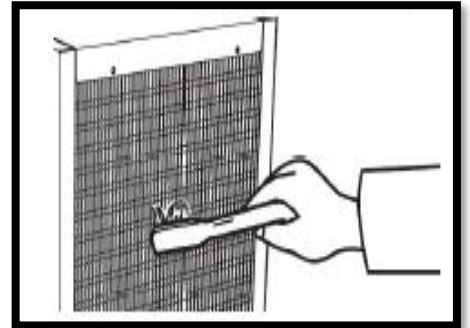

*Air Filter



To prevent deformation do not wash the air filter hot water above 40°



Plastic mesh air filters remove dirt or dust from the air and keep the condenser from getting clogged. If the filters get clogged, the refrigerator/freezer's performance will be reduced.



Check the filters at least twice a month. When clogged or when the temperature controller shows "cH" use warm water and a neutral cleaner to wash the filters. Don't operate the unit with the air filters removed, or the condenser will get clogged, resulting in failure.

- 1) Open the front panel and remove the air filter. To prevent injury, don't touch the condenser fins directly.
- 2) Wash the air filter carefully with cold or warm water containing the proper amount of neutral cleaner. Rinse and dry the air filter thoroughly.
- 3) To refit the air filter, put the two tabs into the heat exchanger or fins in condenser and tightly attach the air filter over the condenser.





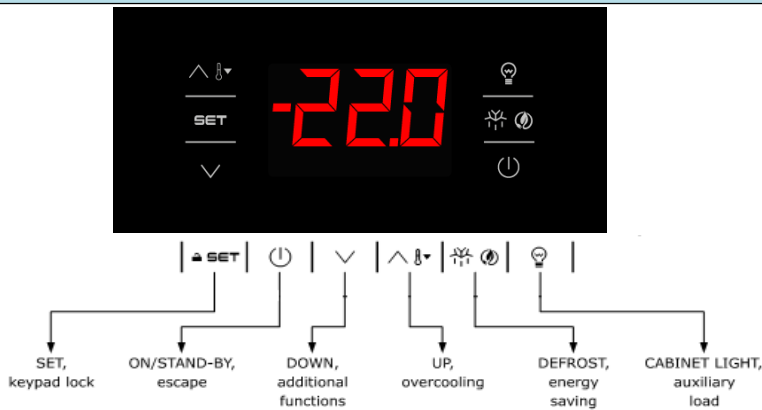





10) Control Elements



Switching the device on and off

If POF = 1 (default), touch the on/stand-by key for 2s

If  the device is switched on, the display will show “P5” value (“cabinet temperature” default); if the display shows an alarm code, see the section *ALARMS*.

LED	ON	OFF	FLASHING
	Compressor on	Compressor off	- compressor protection active - setpoint being set
	Evaporator fan on	Evaporator fan off	- evaporator fan stop active
	Cabinet light on	Cabinet light off	- cabinet light on by digital input
AUX 1	Auxiliary function 1 on	Auxiliary function 1 off	- auxiliary function 1 on by digital input - auxiliary function 1 delay active
AUX 2	Auxiliary function 2 on	Auxiliary function 2 off	- auxiliary function 2 on by digital input - auxiliary function 2 delay active
	Defrost or pre-dip active	-	- defrost delay active - dripping active
	Energy saving active Low consumption active	-	-
	View time	-	- set date, time and day of the current week
	View temperature	-	- overcooling or overheating active
HACCP	Saved HACCP alarm	-	- new HACCP alarm saved
	Alarm active	-	-



HOSHIZAKI EUROPE

If Loc = 1 (default) and 30 sec. have elapsed without the keys being pressed, the display will show the “Loc” label and the keypad will lock automatically.

Unlock keypad

Touch a key for 1 sec: the display will show the label “UnL”.

Set the set point (if r3= 0, default)

Check that the keypad isn’t locked.

1		Touch the SET key
2		Touch the UP or DOWN key within 15 sec. to set the value within the limits r1 and r2 (default “-40..... 50”)
3		Touch the SET key (or do not operate for 15 sec).

Active manual defrost (if r5= 0, default)

Check that the keypad isn’t locked and that overcooling is not active.

1		Touch the DEFROST key for 2 sec.
---	--	----------------------------------

If P3 = 1 (default), defrost is activated provided that the evaporator temperature is lower than the d2 threshold.

Cabinet light on/off (if u1c...u5c = 5)

1		Touch the CABINET LIGHT key.
---	--	------------------------------

Button operated load on/off (if u1c...u5c = 10 or 11)

2		Touch the CABINET LIGHT key. (for 2 sec if u1c...u5c = 5)
---	--	---

If u1c...u5c = 6, the demisting switch on for the u6 duration

Silence buzzer (if u9 = 1, default)

Touch a key.

If u1c...u5c = 11 and u4 = 1, the alarm output is deactivated.

ADDITIONAL FUNCTIONS

Activate/deactivate overcooling and overheating

Check that the keypad is not locked.

1		Touch the UP key for 2 sec
---	--	----------------------------

FUNCTION	CONDITION	CONSEQUENCE
overcooling	r5 = 0 and defrost not active	The setpoint becomes “setpoint – r6” for the r7 duration
overheating	r5 = 1	The setpoint becomes “setpoint + r6” for the r7 duration



Activate/deactivate energy saving in manual mode (if r5= 0)

Check that the keypad is not locked.

1		Touch the DEFROST key.
---	--	------------------------

The setpoint becomes “setpoint + r4” at maximum for HE2 duration.

Activate the high or low humidity functions (if F0 = 5)

Check that the keypad is not locked.

1		Touch the DOWN key for 1 sec.
2		Touch the UP or DOWN key within 15 sec. select the label “rH”.
3		Touch the SET key for 2 sec. until the display shows the right label for the function (only touch the key to see the function activated).
	LAB	DESCRIPTION
	rhL	Low humidity function (evaporator fan with F17 and F18 if the compressor is off, on if the compressor is on).
	rhH	High humidity function (evaporator fan on).
4		Touch the ON/STAND-BY key to exit the procedure (or don't operate for 60 sec.).

View/delete HACCP alarm information (not available in EVJ203, EVJ204, EVJ205, EVJ224 and EVJ225).

Check that the keypad isn't locked.

1		Touch the DOWN key for 1 sec.
2		Touch the UP or DOWN key within 15 sec. select a label.
	LAB	DESCRIPTION
	LS	View HACCP alarm information.
	rLS	Delete HACCP alarm information.
3		Touch the SET key.
4		Touch the UP or DOWN key to select an alarm code (to select label “LS”.) or to set “149” (to select label “rLS”).
	Code	Description
	AL	Low temperature alarm
	AH	High temperature alarm
	id	Open door alarm (If i4 = 1)
	PF	Power failure alarm (available in EVJ213, EVJ214, EVJ214N7VXXRXV, EVJ215, EVJ234, EVJ235 or in EVJ203, EVJ204, EVJ205, EVJ224 and EVJ225 with interface EVIF25TBX connected)



5		Touch the SET key.
6		Touch the ON/STAND-BY key to exit the procedure (or do not operate for 60 sec.).



NOTE: HACCP INFORMATION FOR IN EVJ203, EVJ204, EVJ205, EVJ224 AND EVJ225

HACCP text is display that following situations have been occurred:

- **AL (Low Temperature Alarm):** The read-out provided by the controls for the alarm shows the lowest temperature that has occurred in the cabinet and how long the cabinet temperature has been under the set alarm value (A1).
- **AH (High Temperature Alarm):** The read-out provided by the controls for the alarm shows the highest temperature that has occurred in the cabinet and how long the cabinet temperature has been above the set alarm value (A4).
- **id (Door alarm):** The read-out provided by the controls for the alarm shows the highest temperature that has occurred in the cabinet during this type of alarm and how long the door has been open.

Before starting, check that the keypad isn't locked then execute the following commands.

- 1) Press the "SET" button for 5 sec.
- 2) "PA" (which mean password for short) text will appear on the screen. Then touch the "SET" button again.
- 3) Set the value to "-19" with UP and DOWN arrow buttons and touch the "SET" button.
- 4) Parameter code screen will appear, you should choose "Hr0" parameter and "BLE" parameter with arrow buttons and set these values to "0" (zero). Then wait for a while for the screen to return to the main menu.
- 5) After setting these parameters, the **HACCP** text will disappear.



Example of alarm information (e.g. a high temperature alarm)

8.0	critical value was 8.0 °C / °F (calculated cabinet/product temperature)
Sta	available in EVJ213, EVJ214, EVJ214N7VXXRXV, EVJ215, EVJ234, EVJ235 or in EVJ203, EVJ204, EVJ205, EVJ224 and EVJ225 with interface EVIF25TBX connected
y15	alarm signalled in 2015
n03	alarm signalled in March
d26	alarm signalled on 26 March 2015
h16	alarm signalled at 16.00
n30	alarm signalled at 16.30
dur	
h01	alarm lasted 1 h
n15	alarm lasted 1 h 15 min

View/delete compressor functioning hours.

Check that the keypad is not locked.

1		Touch the DOWN key for 1 sec.
2		Touch the UP or DOWN key within 15 sec. to select a label.
	LAB	DESCRIPTION
	CH1	View compressor functioning hundreds of hours
	CH2	View second compressor functioning hundreds of hours (if u1c...u5c = 1)
	rCH	Delete compressor and second compressor functioning hours
3		Touch the SET key.
4		Touch the UP and DOWN to set "149" (to select "rCH").
5		Touch the SET key.
6		Touch the ON/STAND-BY key to exit the procedure (or don't operate for 60 sec.).



View the temperature detected by the probes.

Check that the keypad is not locked.

1		Touch the DOWN key for 1 sec.
2		Touch the UP or DOWN key within 15 sec. to select a label.
	LAB	DESCRIPTION
	Pb1	Cabinet temperature (if P4 = 0, 1 or 2)
		Inlet air temperature (if P4 = 3)
	Pb2	Evaporator temperature (if P3 = 1 or 2)
	Pb3	Auxiliary temperature (if P4 = 1,2 or 3)
Pb4	Calculated product temperature (CPT; if P4 =3)	
3		Touch the SET key.
4		Touch the ON/STAND-BY key to exit the procedure (or don't operate for 60 sec.).

SETTINGS

Setting configuration parameters.

1		Touch the SET key for 4 sec. the display will show the label "PA"
2		Touch the SET key
3		Touch the UP or DOWN key within 15 sec. to set the PAS value (default "-19")
4		Touch the SET key (or don't operate for 15 sec) the display will show label "SP"
5		Touch the UP or DOWN key to select a parameter.
6		Touch the SET key.
7		Touch the UP or DOWN key within 15 sec. to set the value.
8		Touch the SET key (or don't operate for 15 sec).
9		Touch the SET key for 4 sec. to exit the procedure (or don't operate for 60 sec).



HOSHIZAKI EUROPE

Set the date, time and day of the week (available in EVJ213, EVJ214, EVJ214N7VXXRXV, EVJ215, EVJ234, EVJ235 or in EVJ203, EVJ204, EVJ205, EVJ224 and EVJ225 with interface EVIF25TBX or EVIF25TWX connected)

	<p>N.B.</p> <ul style="list-style-type: none"> - If the device is connected to the interface EVIF25TBX, do not disconnect the device from the mains within two minutes since the setting of the time and day of the week. - If the device communicates with the APP EV connect, the date, time and day of the week will automatically be set by the smartphone or tablet.
--	---









Check that the keypad isn't locked

1		Touch the DOWN key for 1 sec.
2		Touch the UP or DOWN key within 15 sec. to select a label "rtc".
3		Touch the SET key. The display will show the label "y" followed by the last two figures of the year.
4		Touch the UP or DOWN key within 15 sec. to set the year.
5	Repeat actions 3 and 4 to set the next labels.	
	LAB.	MEANING OF THE NUMBERS FOLLOWING THE LABEL
	n	Month (01....12)
	d	Day (01....31)
	h	Time (00....23)
	n	Minutes (00....59)
6		Touch the SET key. The display will show the label for the day of the week.
7		Touch the UP and DOWN key within 15 sec. to set the day of the week.
	LAB.	MEANING OF THE NUMBERS FOLLOWING THE LABEL
	Mon	Monday
	TuE	Tuesday
	Ued	Wednesday
	thu	Thursday
	Fri	Friday
	Sat	Saturday
	Sun	Sunday
8		Touch the SET key. The device will exit the procedure.
9		Touch the ON/STAND-BY key to exit the procedure beforehand.



Reset the factory settings

	<p>N.B. Check that the factory settings are appropriate; see the section <i>CONFIGURATION PARAMETRES</i>.</p>
---	---

1		Touch the SET key for 4 sec. The display will show the label “PA”.
2		Touch the SET key.
3		Touch the UP or DOWN key within 15 sec. to set “149”.
4		Touch the SET key (or don't operate for 15 sec). The display will show label “dEF”
5		Touch the SET key.
6		Touch the UP or DOWN key within 15 sec. to set “1”.
7		Touch the SET key. (or don't operate for 15 sec.)
8	Interrupt the power supply to the device.	
9		Touch the SET key for 2 sec. before action 6 to exit procedure beforehand.



ALARMS

CODE	DESCRIPTION	RESET	TO CORRECT
Pr1	Cabinet Probe Alarm	automatic	<ul style="list-style-type: none"> - check P0 - check probe integrity - check electrical connection
Pr2	Evaporator Probe Alarm	automatic	
Pr3	Auxiliary Probe Alarm	automatic	
rtc	Clock Alarm	manual	Set date, time and day of the week.
AL	Low Temperature Alarm	automatic	Check A0 , A1 and A2
AH	High Temperature Alarm	automatic	Check A4 and A5
id	Open Door Alarm	automatic	Check i0 and i1
PF	Power Failure Alarm	manual	<ul style="list-style-type: none"> - touch a key - check electrical connection
COH	High Condensation Warning	automatic	Check C6
CSd	High Condensation Alarm	manual	<ul style="list-style-type: none"> - switch the device off and on - check C7
iA	Multi Purpose input Alarm	automatic	Check the i5 and i6
iSd	High Pressure Alarm	manual	<ul style="list-style-type: none"> - switch the device off and on - check i5, i6, i8, i9
LP	Low Pressure Alarm	automatic	Check i5 and i6
C1t	Compressor Thermal Switch Alarm	automatic	Check i5 and i6
C2t	Second Compressor Thermal Switch Alarm	automatic	Check i5 and i6
dFd	Defrost Alarm	manual	<ul style="list-style-type: none"> - touch a key - check d2, d3 and d11
FUL	SD Card Full Alarm	manual	Free up space on the SD card or replace it
Sd	No SD Card inserted Alarm	manual	Insert the SD card or replace it



PARAMETER LIST

		BAKER M 550	BAKER F 550
P. CODE	DESCRIPTION	VALUE	VALUE
SP	Set point	3	-20
CA1	cabinet probe offset	0	0
CA2	evaporator probe offset	0	0
CA3	Auxillary probe offset	0	0
P0	probe type	1	1
P1	enable °C decimal point	1	1
P2	temperature unit of measurement	0	0
P3	Evaporator probe function	1	1
P4	configurable input function	1	1
P5	value displayed	0	0
P7	inlet air weight for calculated product temperature	50	50
P8	display refresh time	0	0
r0	setpoint differential	1	4
r1	minimum setpoint	-5	-25
r2	maximum setpoint	12	-5
r3	enable setpoint block	0	0
r4	setpoint offset in energy saving	0	0
r5	cooling or heating operation	0	0
r6	setpoint offset in overcooling/overheating	0	0
r7	Overcooling/overheating duration	0	0
r12	position of the r0 differential	1	1
C0	compressor on delay after power-on	0	0
C1	delay between 2 compressor switch-ons	5	5
C2	compressor off minimum time	3	3
C3	compressor on minimum time	0	0
C4	compressor off time during cabinet probe alarm	5	5
C5	compressor on time during cabinet probe alarm	5	5
C6	threshold for high condensation warning	60	60
C7	threshold for high condensation alarm	100	100
C8	high condensation alarm delay	1	1
C10	compressor hours for service	0	0
C11	compressor 2 on delay	10	10
d00	enable double defrost	0	0
d01	temperature for defrost B activation	2	2
d0	automatic defrost interval	6	6
d0b	automatic defrost interval for B	6	6
d1	defrost type	0	0
d1b	defrost type for B	0	0
d2	threshold for defrost end	8	8
d2b	threshold for defrost end for B	8	8
d3	defrost duration	60	60
d3b	defrost duration for B	60	60
d4	enable defrost at power-on	0	0



HOSHIZAKI EUROPE

P. CODE	DESCRIPTION	BAKER M 550	BAKER F 550
		VALUE	VALUE
d5	defrost delay after power-on	0	0
d6	value displayed during defrost	2	2
d7	dripping time	3	3
d7b	dripping time for B	3	3
d8	defrost interval counting mode	0	0
d9	evaporation threshold for automatic defrost interval counting	0	0
d11	enable defrost timeout alarm	0	0
d15	compressor on consecutive time for hot gas defrost	0	0
d16	pre-dripping time for hot gas defrost	0	0
d18	adaptive defrost interval	999	999
d19	threshold for adaptive defrost (relative to optimal evaporation temperature)	3	3
d20	compressor on consecutive time for defrost	999	999
d21	compressor on consecutive time for defrost after power-on and overcooling	500	500
d22	evaporation threshold for adaptive defrost interval counting (relative to optimal evaporation temperature)	-2	-2
d25	enable air out probe for defrost during evaporator probe alarm	0	0
d26	defrost interval during evaporator probe alarm	6	6
A0	select value for high/low temperature alarms	0	0
A1	threshold for low temperature alarm	10	10
A2	low temperature alarm type	0	0
A4	threshold for high temperature alarm	10	10
A5	high temperature alarm type	0	0
A6	high temperature alarm delay after power-on	120	120
A7	high/low temperature alarms delay	120	120
A8	high temperature alarm delay after defrost	120	120
A9	high temperature alarm delay after door closing	120	120
A10	power failure duration for alarm recording	240	240
A11	high/low temperature alarms reset differential	1	1
F0	evaporator fan mode during normal operation	5	1
F0b	evaporator fan mode during normal operation for B	5	1
F1	threshold for evaporator fan operation	8	8
F2	evaporator fan mode during defrost and dripping	0	0
F2b	evaporator fan mode during defrost and dripping for B	0	0
F3	evaporator fan off maximum time	2	2
F3b	evaporator fan off maximum time for B	2	2
F4	evaporator fan off time during energy saving	30	30
F5	evaporator fan on time during energy saving	6	6
F6	high/low humidity operation	1	1
F7	threshold for evaporator fan on after dripping (relative to setpoint)	5	5



HOSHIZAKI EUROPE

P. CODE	DESCRIPTION	BAKER M 550	BAKER F 550
		VALUE	VALUE
F8	threshold for evaporator fan operation differential	2	2
F9	evaporator fan off delay after compressor off	10	10
F10	condenser fan mode	1	1
F11	threshold for condenser fan on	15	15
F12	condenser fan off delay after compressor off	30	30
F17	evaporator fan off time with low humidity	240	60
F18	evaporator fan on time with low humidity	5	10
i0	door switch input function	5	5
i1	door switch input activation	1	1
i2	open door alarm delay	2	2
i3	regulation inhibition maximum time with door open	10	10
i5	multi-purpose input function	8	8
i6	multi-purpose input activation	0	0
i7	multi-purpose input alarm delay	0	0
i8	number of multi-purpose input activations for high pressure alarm	0	0
i9	reset counter time for high pressure alarm	240	240
i10	door closed consecutive time for energy saving	0	1
i13	number of door openings for defrost	0	0
i14	door open consecutive time for defrost	0	0
u1c	relay K1 configuration	0	0
u2c	relay K2 configuration	4	4
u3c	relay K3 configuration	2	2
u2	enable cabinet light and buttonoperated load in stand-by	0	0
u4	enable alarm output off silencing the buzzer	1	1
u5	threshold for door heaters on	-1	-1
u6	demisting on duration	5	5
u7	neutral zone threshold for heating (relative to setpoint)	-5	-5
U9	enable alarm buzzer	1	1
Hr0	enable clock	0	0
HE2	energy saving maximum duration	720	720
H01	energy saving time	0	0
H02	energy saving maximum duration	0	0
POF	Key activation	1	1
PAS	Access to password	-19	-19
bLE	serial port configuration for connectivity	0	0



11) Switching the Door Hinge Side

The door hinge side can be changed without additional parts. The hinge brackets are asymmetrical, so you must take special care to not get them mixed up – if in doubt, label them before making the modification.



Since physical strength is required to change the door hinges on two opposite ends of the door, the door hinge change should be carried out by two suitably qualified persons for safety reasons. Otherwise, there is a risk of injury and damage to the cabinet.

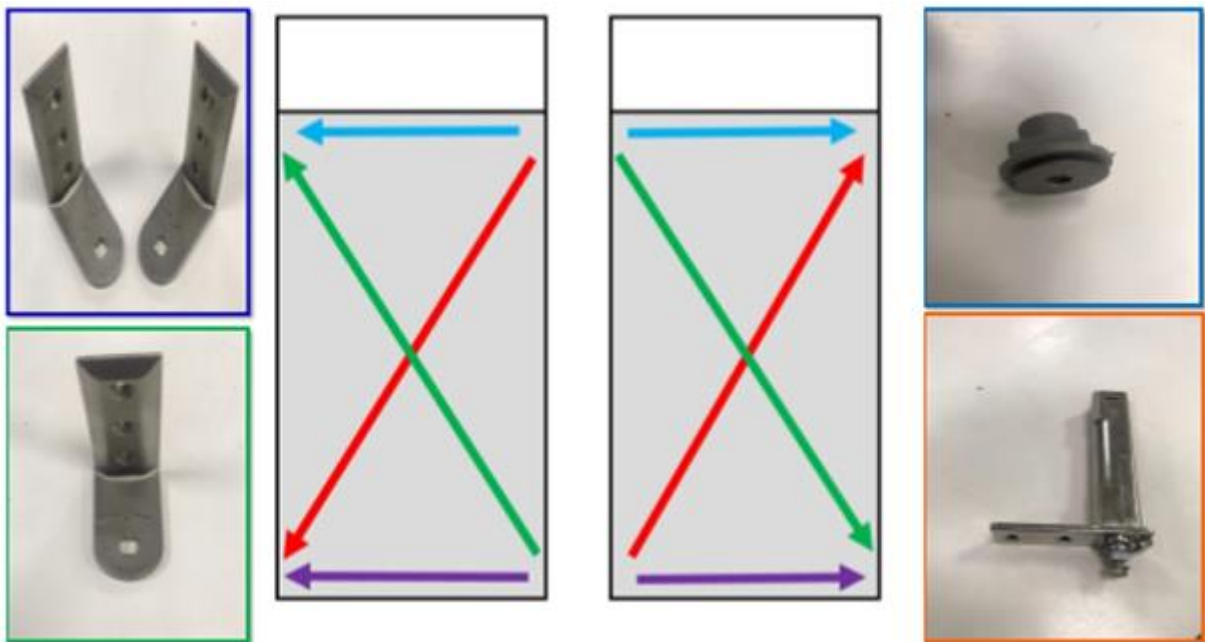

Change from right to left:





The door is turned by 180°, then the hinge brackets are moved diagonally, rotated by 180°. The door closer is moved from the bottom right to the bottom left; the square with M8 internal thread is moved from the top right to the top left.

Change from left to right:

The door is turned by 180°, then the hinge brackets are moved diagonally, rotated by 180°. The door closer is moved from the bottom left to the bottom right; the square with M8 internal thread is moved from the top left to the top right.

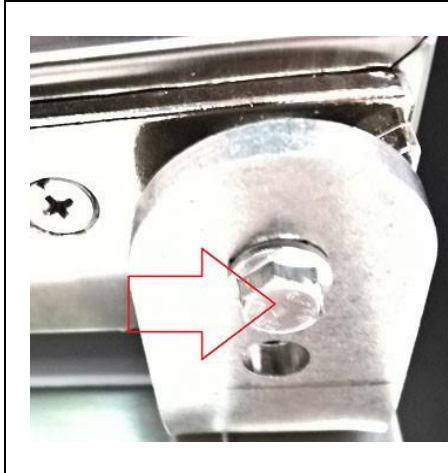

The following description applies to the modification from right to left. In the opposite situation, the corresponding procedure is reversed.

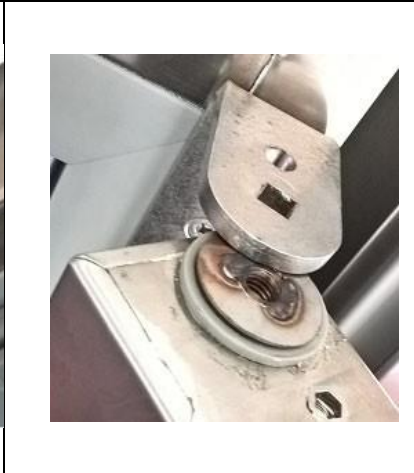
		
<p>1. Remove the fastening screw in the middle at the bottom edge of the canopy.</p>	<p>2. Fold the canopy upwards and secure it against folding back down using adhesive tape or similar.</p> <p> Risk of injury!</p>	<p>3. Open the door at an angle of around 120°.</p>
		
<p>4. Remove the screw from the door closer square at the bottom right hinge (wrench size 8 mm).</p>	<p>5. Remove the fastening screw on the top right hinge (wrench size 13 mm).</p>	<p>6. Pull out the door under the top hinge bracket and lift it out of the lower hinge bracket.</p>



7. Remove the door closer without turning the door closer square.

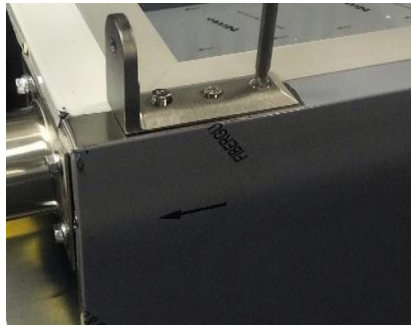

8. Move the hinges from the bottom right to the top left, and from the top right to the bottom left; PH2 screwdriver.



9. Remove the blind plugs for this.



10. Move the lock fitting from the former top edge to the intended top edge of the door.



11. Place the door closer at the bottom left at an opening angle of 180°, and put the bottom left corner of the door over the door closer with the recess provided.



12. Push the top left door corner over the hinge bracket there and screw in the M8 screw.

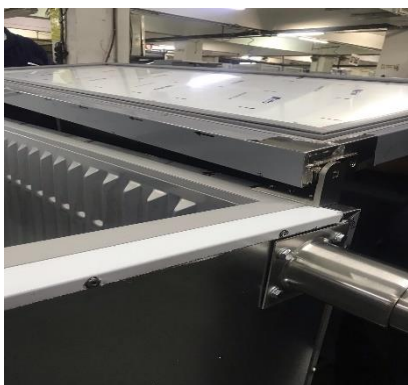

13. Screw in the fastening screws of the door closer at the bottom left.

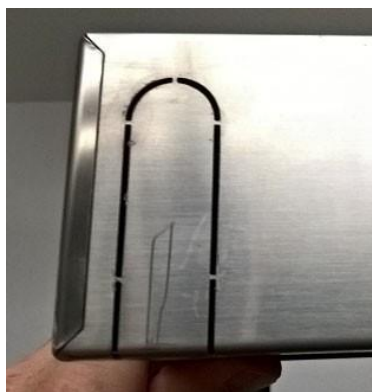

14. Break out the left recess at the bottom of the canopy flap.



15. Close and screw on the canopy.



12) Removing and Reattaching the Evaporator Cover

The cover of evaporator can be removed and reattached for purpose of service according to the following procedure:

Removing the Evaporator Box:

1) There must be no traces of putty on the Evaporator Box surface, it must be removed.	2) Loosen the belts that secure the evaporator box and carefully remove to avoid damage. The Evaporator Box needs to be lifted carefully not damaging box.

Checking and Reattaching the Evaporator Box:

1) Remove all putty from surface of evaporator box.	2) O-ring must be placed in its slot. O-ring should be attached to the box in order to prevent the possibility of air intake.	3) 2-3 mm thick putty should be applied to box duct.



4) Probes and inlet/outlet pipes which connected with Evaporator must cover by PVC insulation tape and make sure all these elements adjust properly.



5) Make sure the sensor position is right and suitable and drain path must be checked.



6) There must be sheet plate under the Defrost Heater to prevent plastic surface from melting.

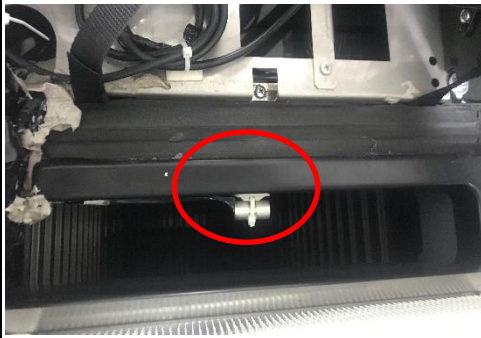

7) Make sure the sensor is correctly positioned and drain path is checked.



8) After fitting the evaporator box secure the belts and do not overtighten. Make sure there are no gaps around the base of the box.



9) Make sure the pipe and cable entry point is fully sealed with putty.



10) Vacuum Breaker must be sealed by putty on Freezer Cabinets, it must be also checked by service technicians!

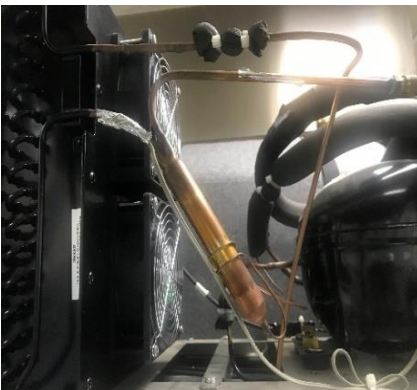
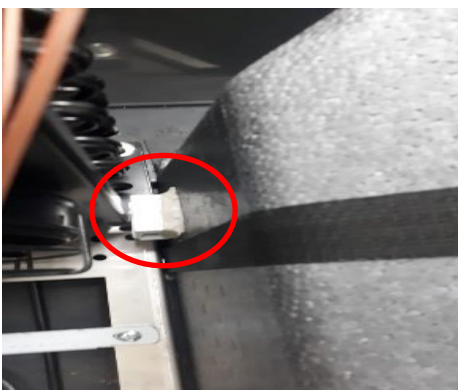

11) When the positioning is done the dryer mustn't touch with any surface.



13) Measures for Taking the Cabinet Out of Operation for Long Periods

- Disconnect the power plug from the socket or switch off the circuit fuse.
- Remove all foods from the cabinet.
- Clean the cabinet (see cleaning section).
- Do not fully close the door; this will prevent unpleasant odors



Warning Please note that as soon as you disconnect the cabinet from the mains, condensation water may drip from the cabinet onto the floor. This could damage the floor and make it slippery.

14) Disposal

Electrical and electronic equipment (EEE) contains materials, components and substances that could pose a threat to humans and the environment if proper disposal (WEEE) is not observed.

Products labelled with a crossed-out bin symbol belong to this group of electrical and electronic components. The crossed-out bin symbol indicates that this type of waste must not be disposed of with regular household waste, but must instead be collected and sorted separately.

If the cabinet requires disposal, this must be carried out in a proper and environmentally friendly manner. The applicable laws and directives related to disposal must be observed.

Please ask your specialist dealer or your local authority about proper disposal.





15) Technical Support and Ordering Spare Parts

Technical support for **resellers and service partners**:

Branches

Hoshizaki UK - UK, Ireland

TEL: +44 845 456 0585
uksales@hoshizaki.co.uk

Hoshizaki Deutschland - Germany, Switzerland, Austria

TEL: +49 (0)5121 697370
vertrieb@hoshizaki.de

Hoshizaki Benelux - Netherlands, Belgium, Luxembourg

TEL: +31 (0)85 0188370
info@hoshizaki.nl

Hoshizaki France - France

TEL: +33 (0)1 48 63 93 80
info@hoshizaki.fr

Hoshizaki Iberia - Spain, Portugal

TEL: +34 (0)93 478 09 52
info@hoshizaki.es

Hoshizaki Denmark - Denmark

TEL.: +45 89 88 53 50
salg@hoshizaki.dk

Hoshizaki Norway - Norge

TEL.: +47 22 88 17 50
salg@hoshizaki.no

Hoshizaki Sweden - Sverige

TLF.: +46 108 84 87 47
OrderSE@hoshizaki.dk

Hoshizaki Italia – Italia

TEL: +39 348 3022156
commerciale@hoshizaki.it

Hoshizaki Europe B.V – All other countries in Europe and Africa

TEL: +31 (0)20 691 84 99
sales@hoshizaki.nl -- <http://hoshizaki-europe.com/>

In the event of faults, please first check if the cabinet is connected to the mains, then check the fault indicator on the display and consult the service manual.

Spare parts can only be ordered **from commercial resellers** (refrigeration specialist companies, dealers, purchasing cooperatives, e.g. BÄKO) and **in writing (e-mail, fax, conventional mail)**.

Please always note the cabinet type, part number and serial number when making enquiries and placing orders. This information can be found on the label.

If you have a smartphone, we recommend sending us a photo of the label and, if in doubt, of the cabinet and the defective part as well.



16) Technical Data:

Placement of the label:

PRODUCT DESCRIPTION LABEL		
1 Product Number		
2 Product Description		
3 Model		
4 Refrigerant (GWP)		
5 CO2 Equivalent		
6 IP Protection		
7 Climate Class		
8 Production Date		
9 Total power / Current / Lamp power		
10 Voltage - Frequency		
11 Heating Element		
12 System Pressure		
13 Blowing Agent		
14 Serial Number		

TRADE MARK			HOSHIZAKI	
MODEL NAME			BAKER M 550	BAKER F 550
Intended Use			Storage	Storage
Chilled Operating Temperature			X	
Frozen Operating Temperature				X
Multiuse Cabinet				
Vertical Cabinet			X	X
Counter Cabinet				
Parameter	Symbol	Unit		
Energy Efficiency Class	EEC	-	B	C
Energy Efficiency Index	EEl	-	34,18	45,26
24 hour Energy Consumption	E _{24h}	kWh	1,086	3,87
Annual Energy Consumption	AEC	kWh	396	1414
Net Volume for Compartment 1	V _n or V _{n1}	litre	335	335
Net Volume for Compartment 2	V _{n2}	litre	-	-
Net Volume for Compartment 3	V _{n3}	litre	-	-
Net Volume for Compartment 4	V _{n4}	litre	-	-
Total Net Volume	V _{nT}	litre	335	335
Climate Class	CC		5	5
Refrigerant			R600a	R290
Charge		kg	0.080	0.085
GWP			3	3
CO ₂ Equivalent			0,24	0,255
Heavy-duty; This appliance is intended for use in ambient temperatures up to 40°C			X	X
Contact Details:			HOSHIZAKI EUROPE B.V. Address: Burgemeester Stramanweg 101 1101 AA Amsterdam, The Netherlands Tel.: +31 (0)20 691 84 99 - http://hoshizaki.europe.com/	



17) Dimensions

BAKER M 550 – BAKER F 550

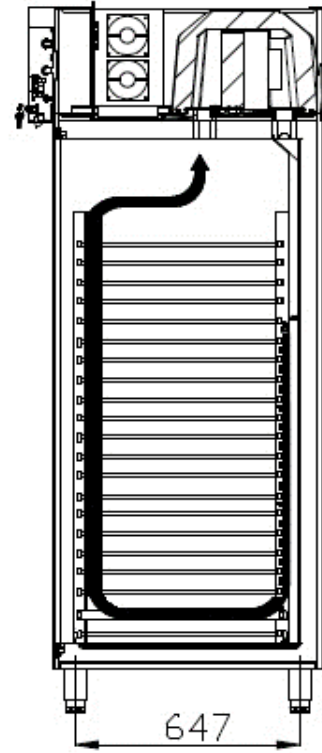
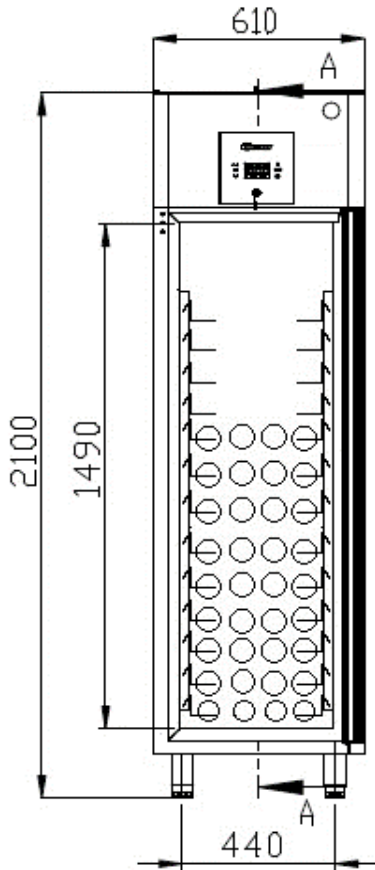

SECTION A-A

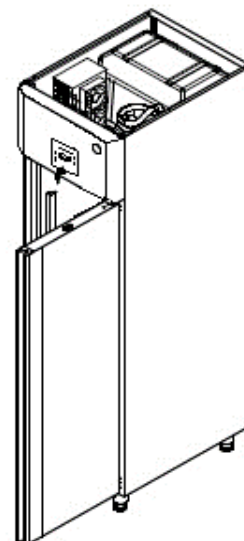
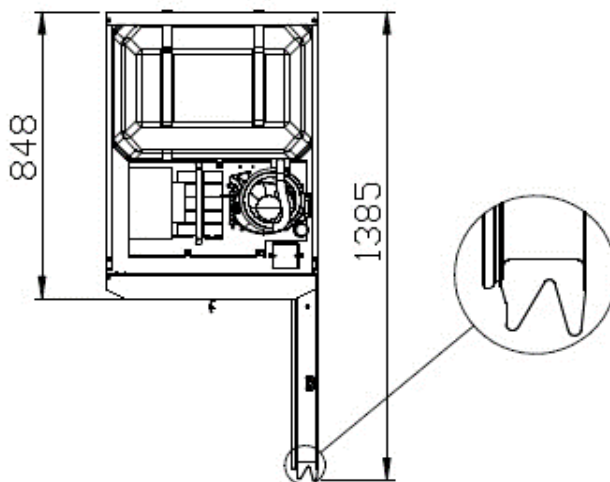



19) Cooling Diagram

