



# BAKERLUX SPEED.Pro™

The first ever baking speed oven



# Index

BAKERLUX SPEED.Pro™	page	<b>4</b>
The formula	page	<b>6</b>
<b>Bake</b> mode	page	<b>8</b>
<b>Speed</b> mode	page	<b>14</b>
SPEED.Pro™ panel	page	<b>24</b>
Unox Technologies	page	<b>26</b>
Data Driven Cooking	page	<b>30</b>
Technical Assistance	page	<b>33</b>
Technical data	page	<b>36</b>
Unox in the world	page	<b>42</b>





Convection baking

## Bake

The traditional soul of BAKERLUX SPEED.Pro™ bakes evenly and enhances fragrances and flavours.

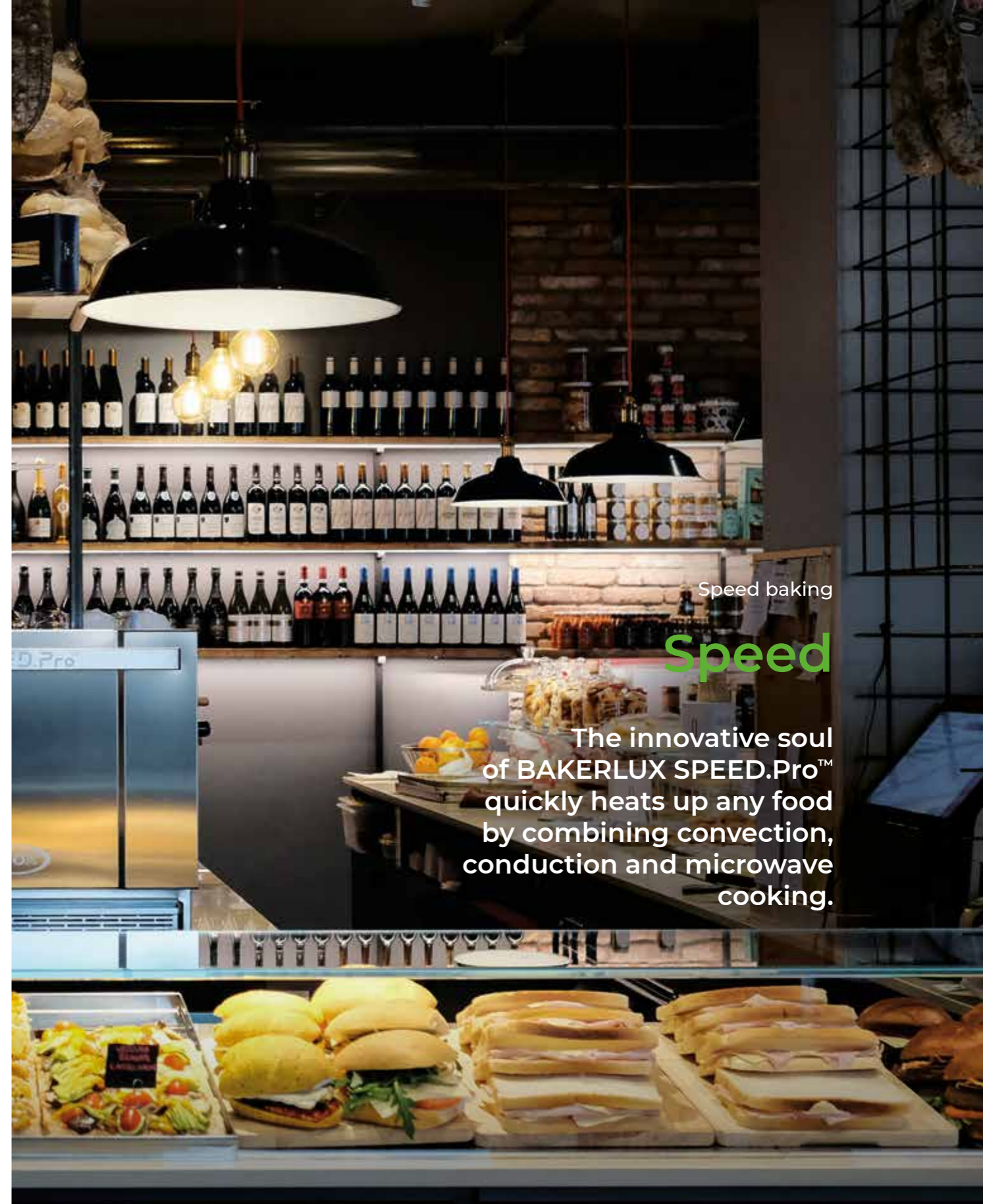

Speed baking

## Speed

The innovative soul of BAKERLUX SPEED.Pro™ quickly heats up any food by combining convection, conduction and microwave cooking.



Maximum performance with the smallest footprint

# The equation that multiplies your profit

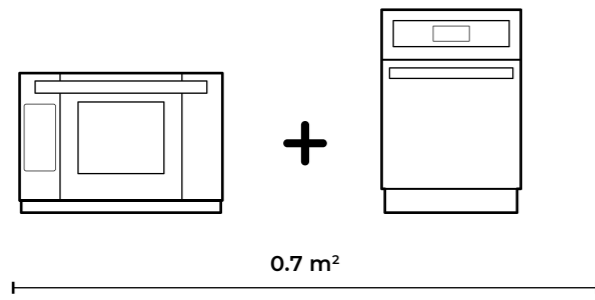

2 in 1

Convection oven and speed oven.  
Two pieces of equipment, double the space,  
double the cost. How often do they actually work  
at the same time?

=

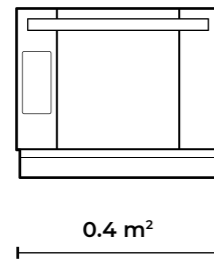

**BAKERLUX SPEED.Pro™**

BAKERLUX SPEED.Pro™ is the first ever  
baking speed oven: a convection oven and  
a speed oven in a single piece of equipment.  
Small footprint, maximum profit.

=

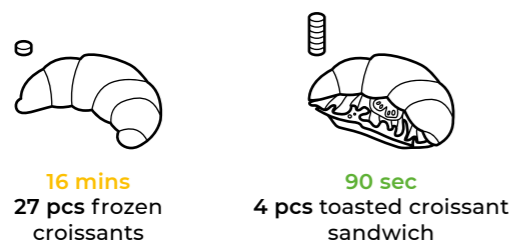

Profit x 3

Fill your baked goods once baked, then heat  
them up in a few seconds when the order  
comes in, serve them hot and fragrant:  
multiply your profit!

Maximum speed

# Triple cooking

**Convection**  
External golden  
browning



**Microwave**  
Fast internal  
heating



**Conduction**  
Crusty toasting  
by contact



BAKERLUX SPEED.Pro™

# Bake mode

The spacious baking chamber with the double-speed fan is ideal to grant fragrant and browned baked goods. Conquer your customer, diversify your offer, increase your profit.

Traditional excellence

# A flawless convection baking

What is the secret to a perfect result?

Convection baking requires perfect control of the air flows in every point of the baking chamber and the effective removal of any excess of humidity.

For BAKERLUX SPEED.Pro™ nothing has ever been so simple.



**Capacity**  
3 460 x 330 trays

**Convection power**  
3.2 kW

**Air speed**  
5 m/s

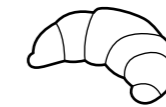

**27** croissants  
in 16 minutes

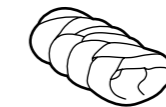

**27** mini strudels  
in 25 minutes



**36** Danish pastries  
in 20 minutes



**45** mini soft rolls  
in 16 minutes



**18** midi baguettes  
in 18 minutes



**3** focaccias  
in 14 minutes



# Baking Essentials

## BAKE

Aluminium tray.



### Ideal for

Pastry;  
Cakes.

### Advantages

Aluminium tray for rapid heat exchange;  
Ultra low edge for maximum baking  
uniformity.

Art. TG305 460 x 330

## FORO.BAKE

Perforated aluminium pan.



### Ideal for

Pizza;  
Focaccia;  
Bread.

### Advantages

Increase the dough sweating during cooking;  
Ultra low edge for maximum baking  
uniformity.

Art. TG310 460 x 330

## FORO.BLACK

Non-stick perforated aluminium pan.



### Ideal for

Croissants;  
Frozen bread;  
Danish pastries and pastry.

### Advantages

Ultra low edge for maximum distribution of air  
flows;  
Baking paper not necessary.

Art. TG330 460 x 330

## BAGUETTE.GRID

Extra-light chromium plated grid - 5 channels.

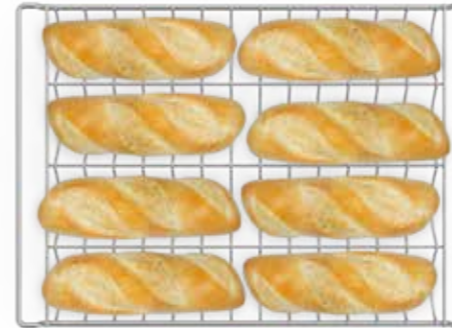

### Ideal for

Frozen baguettes;  
Frozen midi-baguettes.

### Advantages

Maximizes the air circulation on every surface  
of the bread.

Art. GRP310 460 x 330

## PAN.FRY

Non-stick steel pan.



### Ideal for

Pizza;  
Quiche lorraine;  
Pre-fried foods.

### Advantages

20 mm depth.

Art. TG350 460 x 330

## STEEL.GRID

Non-stick stainless steel grid.



### Ideal for

Frozen pizzas;  
Frozen bread.

### Advantages

Maximizes the air circulation on every surface  
of the food.

Art. GRP335 460 x 330

BAKERLUX SPEED.Pro™

# Speed mode

The plate for speed mode makes it possible to heat both single and multiple portions of food in seconds. Service times are halved, your profits doubled.



Innovative excellence

# Multi-portion speed baking



Cooking Performance



**9 croissants**  
in 10 minutes



**250 gr lasagna**  
in 16 minutes



**4 club sandwiches**  
in 125 seconds



**250 gr chicken wings**  
in 18 minutes

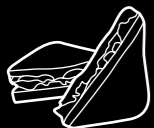

**4 toasted sandwiches**  
in 75 seconds



**4 burritos**  
in 90 seconds

SPEED.Pro™ - Speed

How much does it cost you to keep your customers waiting?

# Get rid of all waiting, multiply your earnings

The limited size of the pan of a traditional speed oven does not allow you to cook more than one sandwich at a time. This translates into prolonged waiting times at rush hours.

Thanks to BAKERLUX SPEED.Pro™ and the 460 x 330 mm surface of the special SPEED.Plate tray you can bake up to 4 or more sandwiches at the same time to never keep your customer waiting.

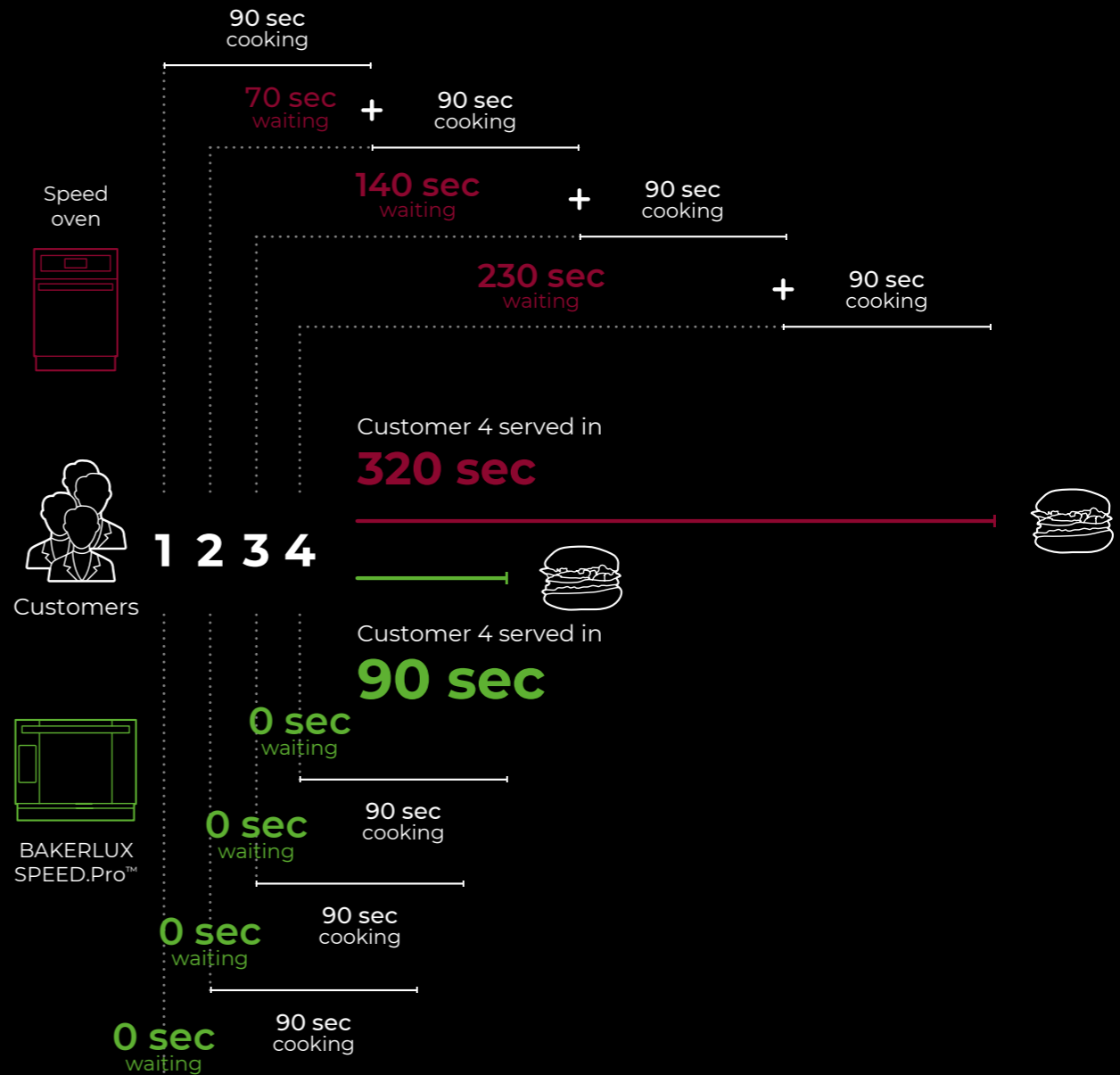

Cooking Performance

SPEED.Pro™ - Speed

The plate that speeds up time

# SPEED.Plate

The SPEED.Plate plate accumulates heat during the preheat or when the oven is in stand-by mode and releases it quickly as soon as the food is put onto it. The non-stick coating makes it easy to clean.



## Flat side

The flat surface quickly heats up and browns the bottom surface of the food and gives it an intense and uniform color. The side and rear lips make it easy to position the food and remove it.

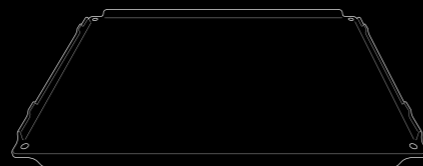

Art. TG360 460 x 330

## SPEED.Pro™ spatulas

Quickly unload products without any risk thanks to the ergonomic handle of our SAFE.Hand spatula which prevents any contact with hot surfaces.

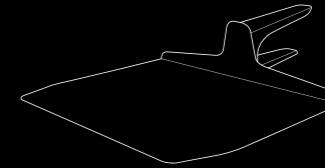

Art. XUC165  
Technical details on page 41

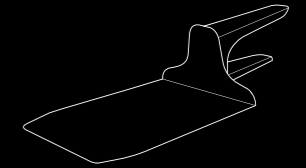

Art. XUC166  
Technical details on page 41



## Ribbed side

The ribbed side of the SPEED.Plate allows a more effective removal of humidity from the bottom surface of the product. Ideal for club sandwiches, breads without crust or deli.

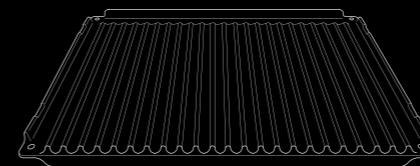

Art. TG360 460 x 330



Rapid marks

# SPEED.Grid

The SPEED.Grid grid allows you to obtain intense markings on every type of product. Combined with the special toothed scoop, it allows easy positioning and food extraction.

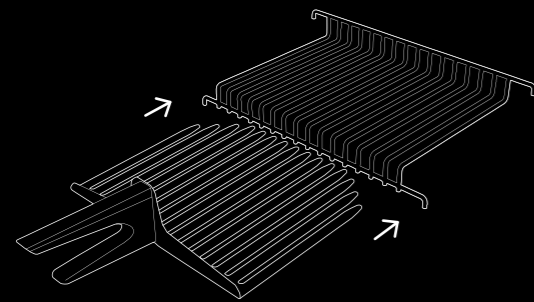

## Intense markings and ease of use

Quick to preheat, simple to use. The stainless steel SPEED.Grid quickly heats up food from which humidity needs to be taken out from its bottom surface, such as toast or white bread, or to quickly position ceramic dishes or any other recipient resistant to high temperatures.

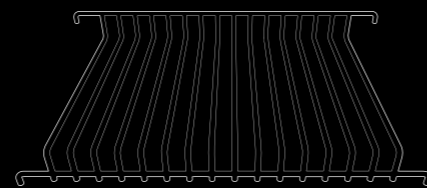

Art. GRP360 460 x 330

## SPEED.Pro™ spatulas

Quickly load and unload products without any risk thanks to the ergonomic handle of our SAFE.Hand spatula which prevents any contact with hot surfaces.

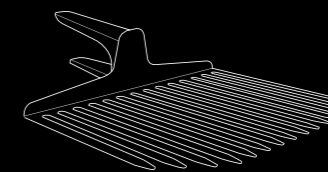

Art. XUC167  
Technical details on page 41

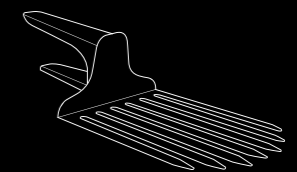

Art. XUC168  
Technical details on page 41



Invented to simplify your work

# Intelligent technology

The Unox technology applied to BAKERLUX SPEED.Pro ovens is designed to automatically manage the cooking and heating process of food and thus allows you to focus on what is most important to you.

Bake interface

# Convection mode

The BAKE mode allows you to carry out convection baking programs made of several steps, store the most used programs or use the automatic CHEFUNOX programs.

Ideal for frozen bakery products, but also capable of cooking other types of food, it allows you to reduce the cooking process times by inserting one or more steps that combine convection and microwaves.



### Set

Up to 9 baking steps for each program



### Programs

384 programs memory



### CHEFUNOX

Select what you want to bake and the result you are looking for



Speed interface

# Speed mode

The SPEED mode allows you to quickly heat up any type of food, memorise the most used programs or use the SPEEDUNOX automatic processes.

The oven remains at working temperature even during the stand-by phases to always be ready and to heat up your dishes in seconds. ADAPTIVE.Cooking technology automatically adjusts the cooking process according to the actual food load.



### Set

Up to 9 cooking steps for each program



### Programs

384 programs memory



### SPEEDUNOX

Select what you want to bake and the result you are looking for





Unox Technologies

# Performance with no compromises

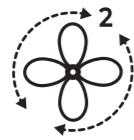

AIR.Plus

### It conducts, unites, transforms.

It guarantees perfect air and heat distribution within the baking chamber, for uniform results at every point throughout every tray, for all trays.



DRY.Plus

### Extracting humidity for maximum flavour.

It extracts humidity from the baking chamber, thus helping the internal structure of the product to form properly and guaranteeing a texture that remains the same even hours after it has finished baking.



SPEED.Plus

### The cooking accelerator.

The combined work of a microwave generator, the geometry of the waveguides and of the cooking chamber and the high-speed fan with stirring function ensures the even distribution of the microwaves on each point of the plate.

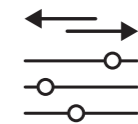
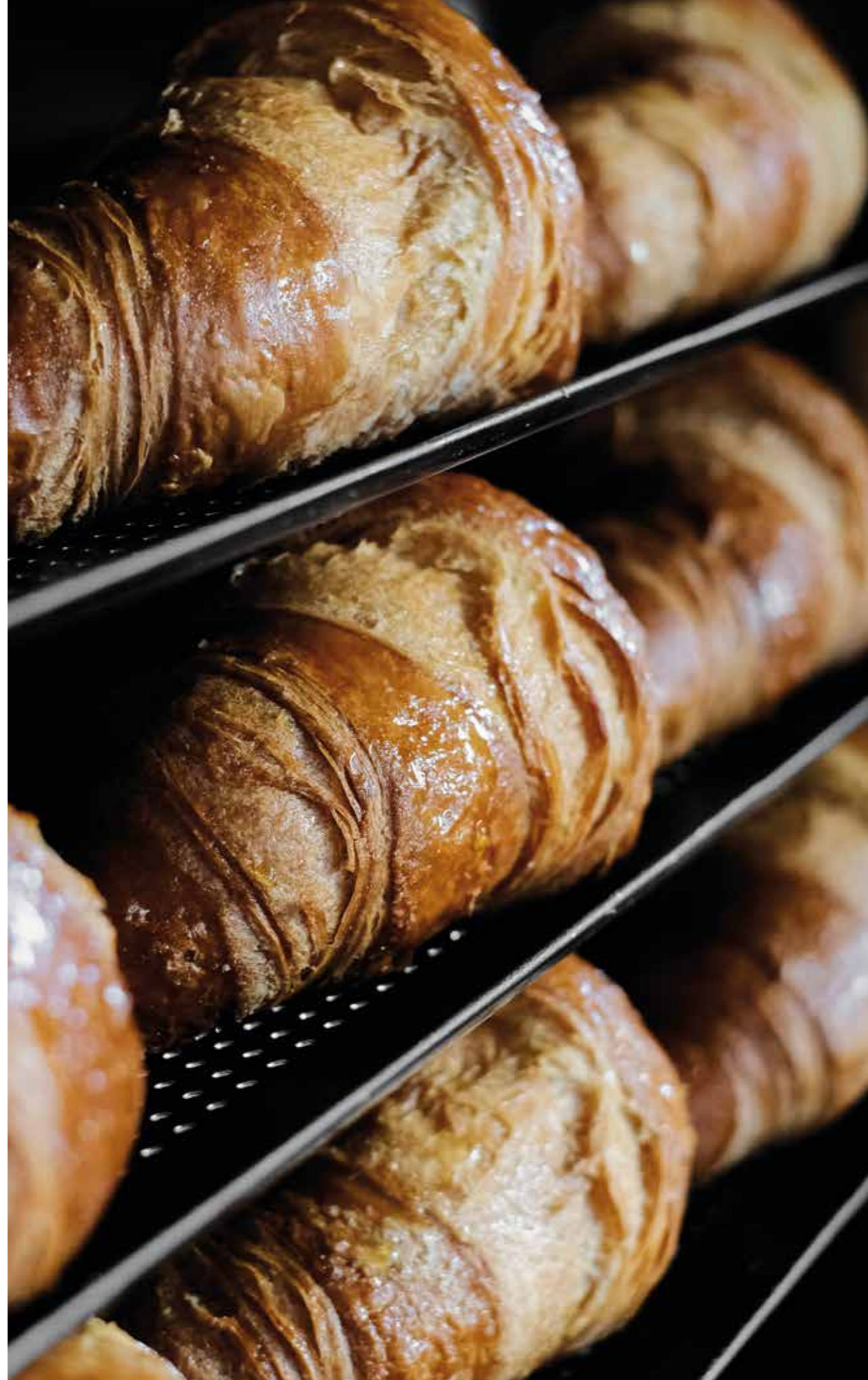

ADAPTIVE.Cooking™

### Perfect results. Every time.

By registering changes in humidity and temperature, the oven automatically adjusts the cooking process to the actual food-load to deliver an identical and perfect result every time.



SMART.Preheating

### Intelligent preheating.

Combining the analysis of previous cooking processes with the requirements of the next one, the oven automatically sets the best temperature and preheating time to guarantee maximum repeatability of results throughout the day, therefore reducing waiting time.



AUTO.Soft

### Gentle cooking function.

When activated, the oven automatically regulates the rise in temperature to make it more gentle and guarantee an optimal heat distribution on each pan in the oven. The best for delicate and heat-sensitive foods.



Designed by your desires

## Services

**Our promise is your guarantee of solid performance. Stay focused on your goals knowing that we are always by your side.**

Anton Bodyashkin - Ugli Restaurant - Russia





Data will be always accessible by smartphone or PC

# An ecosystem to be discovered

Create and share



**Your recipes in all your ovens.**  
Create your recipe book and synchronise it with all your ovens with just one click, keeping all your kitchens or stores up to date. You may create it directly from one of your ovens or from your PC.

Understand



**Monitor and improve your performance.**  
DDC.Stats gives you full control over energy, water, and detergent consumption and over your cooking times and oven usage. Compare the performances, detect anomalies and get useful information to improve the efficiency of the ovens in your network.

360° Assistance

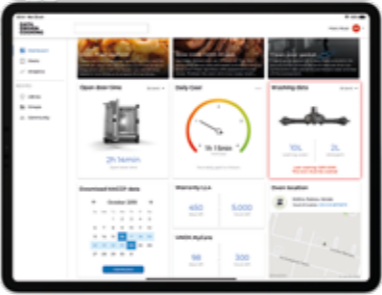

**Let DDC.Coach train you.**  
DDC.Coach is a digital assistant that provides you with advice based on the actual use of your ovens. This allows you to take full advantage of their potential. Capitalise on the abilities of your ovens and maximise the return on your investment!

Data Driven Cooking

# Create. Understand. Improve.

The Data Driven Cooking Artificial Intelligence transforms the consumption data of your oven into useful information that allows you to increase your daily profit.

# Technical Assistance

## Installation

### The right partner next to your kitchen

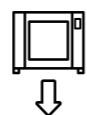

#### A global Service network

A perfect installation is essential to guarantee the correct functioning of your MIND.Maps™ PLUS oven and eliminate interruptions in your daily work. We focus on you, so you can focus on what matters to you. Find the authorised Service Centers nearest to your kitchen.

## Maintenance

### Don't stop your kitchen



#### The quickest on site Service

When connected to the internet, your oven communicates directly with our Service Team, so we can intervene as soon or even before maintenance is required. Keeping your oven in optimal condition is Unox' priority: our technicians are at your disposal to provide you the best online and on-site support.

## LONG.Life warranty

### A promise of reliability



#### A choice made to last

Passion does not allow any distraction and to deal with the unexpected you need reliable assistants by your side. Thanks to Unox and its LONG.Life program, you will have the assistance of our specialised technicians and 12 month warranty covering labour and spare parts. All our products are designed to last a long time, assure you the best possible technology and allow you to face any challenge. Thus you will have to worry only about fostering your success.

\*Check the Warranty Conditions for your country at [unox.com](http://unox.com)

\*\*The LONG.Life warranty on magnetron covers 500 working hours.



Data sheet, features and accessories

# **The first ever baking speed oven**

# BAKERLUX SPEED.Pro™

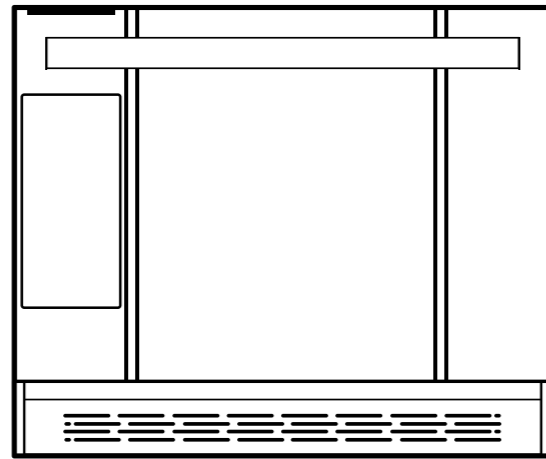

600 x 797 x 541 mm  
w x d x h

**XESW - 03HS - EDDN**

capacity 3 460 x 330

pitch 75 mm

frequency 50 Hz

voltage 380-415 V 3 PH+N+PE

power 6.5 kW

weight 88 kg

Note  
All BAKERLUX SPEED.Pro™ ovens have SPEED.Plato and 3 BAKE trays included.



## Technical details



Stainless steel AISI 304 cooking chamber with integrated tray support

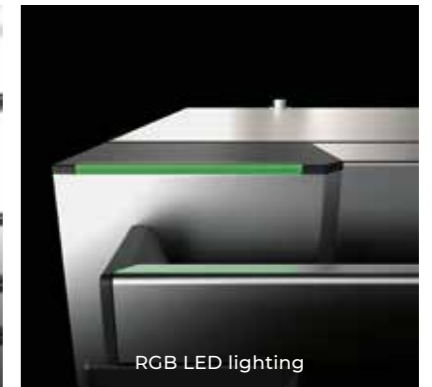

RGB LED lighting



Wi-Fi connection



Panel with integrated USB



4 speed multiple fan system with high performance heating elements



Catalytic converters integrated in the cooking chamber to reduce odors



Component aeration filter with integrated removable and washable crumb collection

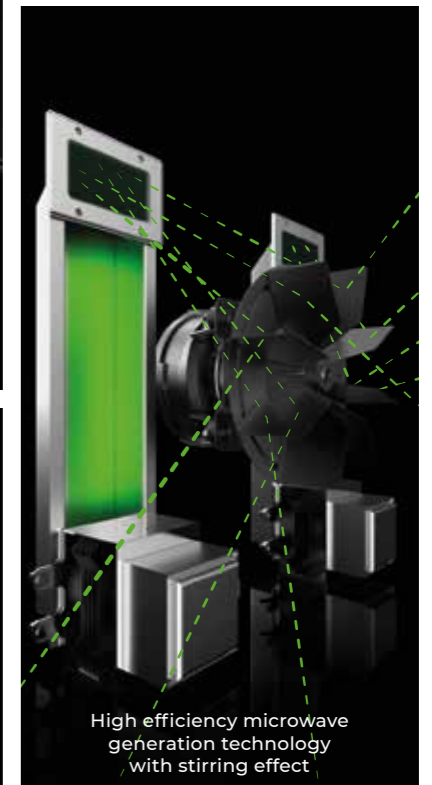

High efficiency microwave generation technology with stirring effect



Solutions that maximise your investment

# Increase your Possibilities

Configurations



## **SPEED.Pro™ + SPEED.Pro™**

Use the side-by-side positioning or stacking kits to install multiple units in minimal space.



## **LIEVOX + SPEED.Pro™ + SHOP.Pro MASTER**

For the most demanding customers, the prover allows you to exploit the full potential of BAKERLUX SPEED.Pro™ as a baking oven.



## **SPEED.Pro™ + EVEREO®**

Combined with EVEREO®, SPEED.Pro™ allows you to create a retail shop capable of quickly serving any type of food.

Configurations

# Features

## UNOX INTELLIGENT PERFORMANCE

- ADAPTIVE.Cooking™: automatically adjusts the cooking parameters to ensure repeatable results
- SMART.Preheating: automatically sets temperature and preheating duration
- AUTO.Soft: manages the rise in temperature to make it more delicate

## UNOX INTENSIVE COOKING

- DRY.Plus technology: extracts humidity from the baking chamber
- AIR.Plus: fan with reversing gear and 2 adjustable speeds
- SPEED.Plus: generates microwaves and distributes them evenly throughout the baking chamber

## DATA DRIVEN COOKING

- Wi-Fi connection
- Ethernet connection
- ddc.unox.com: monitor the usage in real time, create and send recipes from your pc to your ovens
- DDC.Stats: analyse, compare and improve your oven usage and consumption data
- DDC.App: monitor your connected ovens in real time from your smartphone
- DDC.Coach: it analyzes the way you use the oven and suggests you new personalised recipes

## MANUAL BAKING

- Convection cooking from 30 °C to 260 °C
- Convection cooking + microwave from 30 °C
- Maximum preheating temperature 260°C

## ADVANCED AND AUTOMATIC COOKING

- PROGRAMS: save up to 896 programs with their name, image or handwritten signature
- CHEFUNOX: choose what to cook from the library and the oven will automatically set all the parameters
- SPEEDUNOX: choose what to cook from the library and the oven will automatically set all the parameters for the speed mode
- 9 baking steps
- 24 quick programs (12 SPEED and 12 BAKE)

## AUXILIARY FUNCTIONS

- Preheating temperature up to 260 °C - adjustable by the user for each program
- End of cooking time display
- Holding cooking mode «HOLD» and continuous functioning «INF»
- Visualisation of the nominal value of baking chamber temperature
- Temperature units shown in °C or °F

## PERFORMANCE AND SAFETY

- Protek.SAFE™: electrical power absorption related to the real needs
- Protek.SAFE™: Cool external surfaces

## TECHNICAL DETAILS

- Rounded stainless steel AISI 304 cooking chamber
- Baking chamber with integrated tray supports
- Visual display of the baking status by means of multicoloured LEDs
- Control panel with water resistance certification - IPX3
- Crumb collection system integrated in the filter under the door
- Heavy duty structure with innovative materials
- 2 speed multiple fan system with high performance round heating elements
- Drop down door opening
- Proximity door contact switch
- Autodiagnosis system for problems or brake down
- Safety thermostat

# Accessories

## PROOFERS

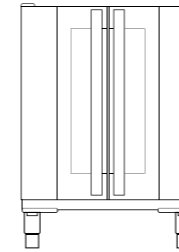

**LIEVOX**  
8 460 x 330  
600 x 711 x 750 mm - w x d x h  
Art. XEKPT-08HS-C

**LIEVOX WITH BOILER**  
8 460 x 330  
600 x 711 x 750 mm - w x d x h  
Art. XEKPT-08HS-B

## SPATULA

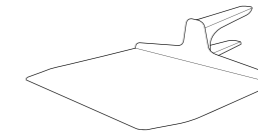

**FLAT SPATULA**  
Non-stick aluminum spatula for SPEED.Plate  
365 x 477 x 92 mm - w x d x h  
Art. XUC165

Non-stick aluminum spatula for SPEED.Plate  
165 x 427 x 92 mm - w x d x h  
Art. XUC166

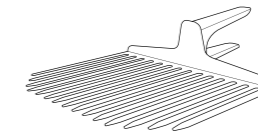

**COMB SPATULA**  
Aluminum spatula for SPEED.Grid  
365 x 477 x 92 mm - w x d x h  
Art. XUC167

Aluminum spatula for SPEED.Grid  
165 x 427 x 92 mm - w x d x h  
Art. XUC168

## STAND

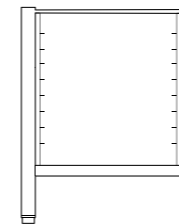

**HIGH STAND**  
594 x 546 x 738 mm - w x d x h  
Art. XWKRT-08HS-H

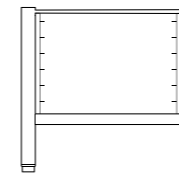

**INTERMEDIATE STAND**  
594 x 546 x 559 mm - w x d x h  
Art. XWKRT-06HS-M



**LOW STAND**  
594 x 546 x 355 mm - w x d x h  
Art. XWVRC-0011-M

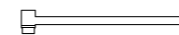

\*Mandatory for oven positioning on the floor

**FLOOR POSITIONING**  
594 x 546 x 150 mm - w x d x h  
Art. XWKRT-00HS-F

## WHEELS AND FEET

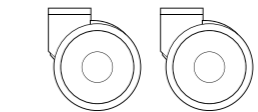

**WHEELS KIT**  
2 wheels with brake - 2 wheels without brake - safety chains  
Art. XUC012

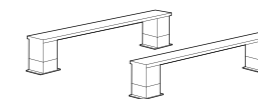

**FEET KIT**  
2 brackets with feet for oven positioning on a table  
Art. XUC025

## CONNECTION

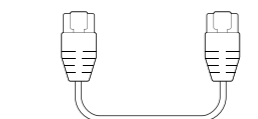

**ACCESSORIES FOR THE OVENS CONNECTION**  
Ethernet connection kit  
Art. XEC011

## CLEANING AGENTS



**SPRAY&Rinse**  
Spray detergent  
Art. DB1044



**ACCESSORIES FOR THE OVENS CONNECTION**  
Wifi connection kit  
Art. XEC012



Global company. Best Services Worldwide.

# Unox in the world

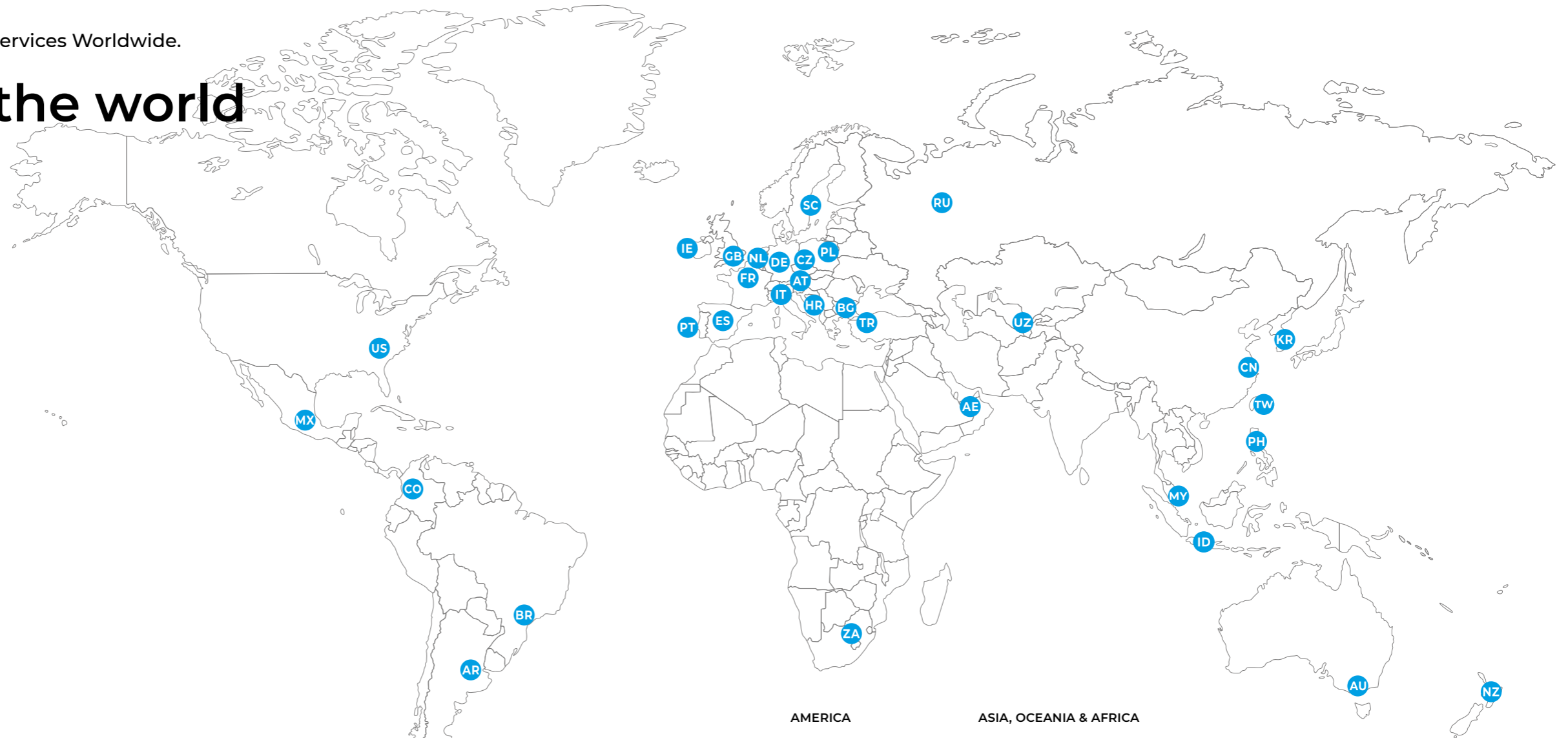

Contacts

Contacts

## INTERNATIONAL

**UNOX S.p.a**  
Via Majorana, 22  
35010 - Cadoneghe (PD) - Italy  
E-mail: info@unox.com  
Tel: +39 049 8657511

## EUROPE

**IT - ITALIA**  
**UNOX S.p.a**  
E-mail: info@unox.it  
Tel: +39 049 8657511

**DE - DEUTSCHLAND**  
**UNOX DEUTSCHLAND GMBH**  
E-mail: info.de@unox.com  
Tel: +49 2951 98760

**FR - FRANCE, BELGIUM & LUXEMBOURG**  
**UNOX FRANCE s.a.s.**  
E-mail: info.fr@unox.com  
Tel: +33 4 78 17 35 39

**PT - PORTUGAL**  
**UNOX PORTUGAL**  
E-mail: info.pt@unox.com  
Tel: +351 918 228 787

**ES - ESPAÑA**  
**UNOX PROFESIONAL ESPAÑA S.L.**  
E-mail: info.es@unox.com  
Tel: +34 900 82 89 43

**GB - UNITED KINGDOM**  
**UNOX UK Ltd.**  
E-mail: info@unoxuk.com  
Tel: +44 1252 851 522

**IE - IRELAND**  
**UNOX IRELAND**  
E-mail: info.ie@unox.com  
Tel: +353 (0) 87 32 23 218

**SC - SCANDINAVIAN COUNTRIES**  
**UNOX SCANDINAVIA AB**  
E-mail: info.se@unox.com  
Tel: +46(0)790 75 63 64

**AT - ÖSTERREICH**  
**UNOX ÖSTERREICH GMBH**  
E-mail: info.de@unox.com  
Tel: +43 800 880 963

**RU - РОССИЯ, ПРИБАЛТИКА И СТРАНЫ СНГ**  
**UNOX РОССИЯ**  
E-mail: info.ru@unox.com  
Tel: +7 (499) 702 - 00 - 14

**CZ - ČESKÁ REPUBLIKA**  
**UNOX DISTRIBUTION s.r.o.**  
E-mail: info.cz@unox.com  
Tel: +420 241 940 000

**HR - HRVATSKA**  
**UNOX CROATIA**  
E-mail: narudzbe@unox.com  
Tel: +39 049 86 57 538

**BG - БЪЛГАРИЯ**  
**UNOX BULGARIA**  
E-mail: info.bg@unox.com  
Tel: +359 2 419 05 00

**PL - POLSKA**  
**Unox Polska Sp.zo.o.**  
E-mail: info.pl@unox.com  
Tel: +48 665 232 000

**TR - TÜRKİYE - UNOX TURKEY**  
Profesyonel mutfak ekipmanlari endüstri ve ticaret limited şirketi  
E-mail: info.tr@unox.com  
Tel: +90 530 176 62 03

**NL - NETHERLANDS**  
**UNOX NETHERLANDS B.V.**  
E-mail: info.nl@unox.com  
Tel: +31 6 27 21 14 10

## AMERICA

**US - U.S.A. & CANADA**  
**UNOX Inc.**  
E-mail: info.usa@unox.com  
Tel: +1 800 489 8669

**CO - COLOMBIA**  
**UNOX COLOMBIA**  
E-mail: info.co@unox.com  
Tel: +57 350 65 88 204

**BR - UNOX BRASIL**  
**SERVICOS LTDA.**  
E-mail: info.br@unox.com  
Tel: +55 11 98717-8201

**AR - ARGENTINA**  
**UNOX ARGENTINA**  
E-mail: info.ar@unox.com  
Tel: +54 911 37 58 43 46

**MX - MEXICO**  
**UNOX MEXICO, S. DE R.L. DE C.V.**  
E-mail: info.mx@unox.com  
Tel: +52 55 8116-7720

## ASIA, OCEANIA & AFRICA

**ZA - SOUTH AFRICA**  
**UNOX SOUTH AFRICA**  
E-mail: info.sa@unox.com  
Tel: +27 845 05 52 35

**AE - U.A.E.**  
**UNOX MIDDLE EAST DMCC**  
E-mail: info.uae@unox.com  
Tel: +971 4 554 2146

**UZ - UZBEKISTAN**  
**UNOX PRO LLC**  
E-mail: info.uz@unox.com  
Tel: +998 90 370 90 10

**CN - 中华人民共和国**  
**UNOX TRADING (SHANGHAI) Ltd. CO.**  
电子邮件: info.china@unox.com  
电话: +86 21 56907696

**MY - MALAYSIA & SINGAPORE**  
**UNOX (ASIA) SDN. BHD**  
E-mail: info.asia@unox.com  
Tel: +603-58797700

**PH - PHILIPPINES**  
**UNOX PHILIPPINES**  
E-mail: info.asia@unox.com  
Tel: +63 9173108084

**ID - INDONESIA**  
**UNOX INDONESIA**  
E-mail: info.asia@unox.com  
Tel: +62 81908852999

**KR - 대한민국**  
**UNOX KOREA CO. Ltd.**  
이메일: info.asia@unox.com  
전화: +82 2 69410351

**TW - TAIWAN, HONG KONG & MACAU**  
**UNOX TAIWAN**  
E-mail: info.tw@unox.com  
Tel: +886 928 250 536

**AC - OTHER ASIAN COUNTRIES**  
**UNOX (ASIA) SDN. BHD**  
E-mail: info.asia@unox.com  
Tel: +603-58797700

**AU - AUSTRALIA**  
**UNOX AUSTRALIA PTY Ltd.**  
E-mail: info@unoxaustralia.com.au  
Tel: +61 3 9876 0803

**NZ - NEW ZEALAND**  
**UNOX NEW ZEALAND Ltd.**  
E-mail: info@unox.co.nz  
Tel: +64 (0) 800 76 0803

SPEED.Pro™

SPEED.Pro™



INVENTIVE SIMPLIFICATION

[unox.com](http://unox.com)



LI1944A0 printed on 03-2020

All images used are for illustrative purposes only.

All features indicated in this catalogue may be subject to change and could be updated without notice.