

item #
 model #
 project #
 sis #
 aia #

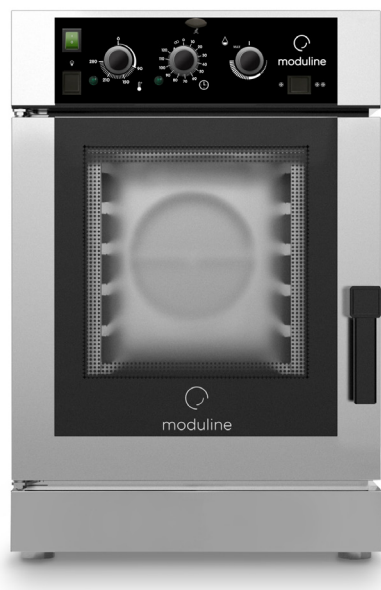

COMBI GCE106C

Combi oven

CONSTRUCTION FEATURES

- Tightness chamber with radiused corners
- Total thermic insulation with rock or glass wool
- Long lasting front seals made up of food grade of high heat resistance
- Removable side racks to facilitate cleaning
- Internal drain for easy cleaning
- Ventilated heating provided by high efficiency protected heating elements
- Snap-shut door
- Adjustable feet
- Easy access to facilitate maintenance and repair
- Double low-emission glass door with internal ventilation
- Openable inside glass of the door
- Condensation drip tray under the door and connected to the oven drainage system.

FUNCTIONAL FEATURES

- Electromechanical controls: main switch, lights switch, timer, moisture, temperature, fan speed
- Simplified, user-friendly controls
- Periodic reversal of direction of rotation of the fan for better air distribution
- Automatic stopping of fans when the door is opened
- Manual humidity vent
- End-of-cycle buzzer
- Chamber with safety thermostat
- Operating temperature: from 30°C to 280°C
- SpeedGrade fan speed adjustment
- Glazed door plus lighting
- Removable GN1/1 tray racks

OPTIONS & ACCESSORIES

- Supports
- External hand shower
- Water filter system
- Grids
- Trays
- Opposite side opening
- Door lock with key
- Cooling drainage system





MODULINESRL

Via dell'Industria 11, Z.I. San Giacomo di Veglia 31029 Vittorio Veneto (TV) - ITALY
 tel. +39 0438 5063 - fax +39 0438 912 323 - info@moduline.it - www.moduline.it



moduline

TECHNICAL INSTALLATION DIAGRAM

- Electricity supply cable inlet 
- Safety vent humidity 
- Chamber drain 
- Softened water inlet 

Important - Drawing and dimensions refer to the standard version. They may change with the addition of accessories or options.

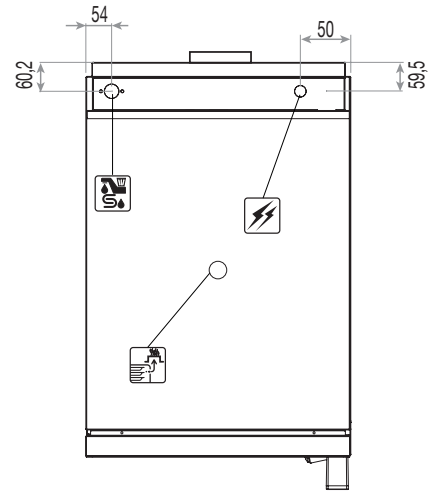
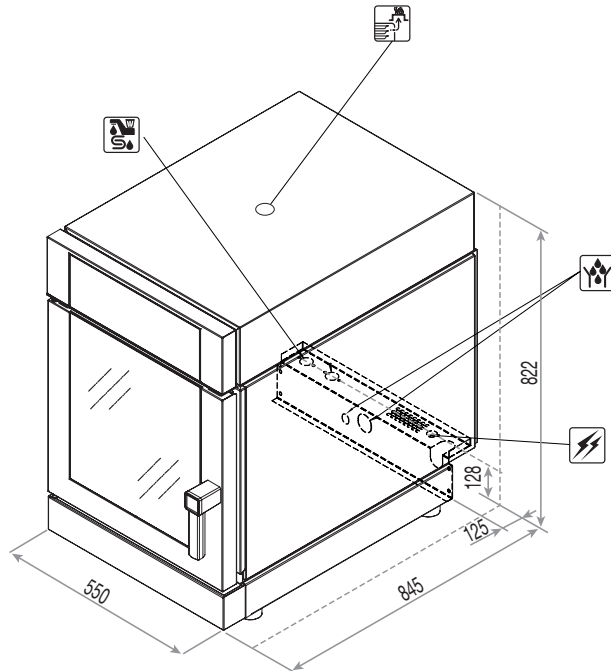

Overall dimensions (W x D x H) - mm	550 x 845 x 822h	Product max capacity [Kg]	15
Trays capacity	6 x GN 1/1	Total input [kW]	7,8 (400V)
Distance [mm]	64	Amps. [A]	11,3 (400V)
Power supply	380-415V 3N 50/60Hz	Water pressure [kPa]	150 ÷ 500
Working temperature [°C]	30 ÷ 280	Net weight [Kg]	90

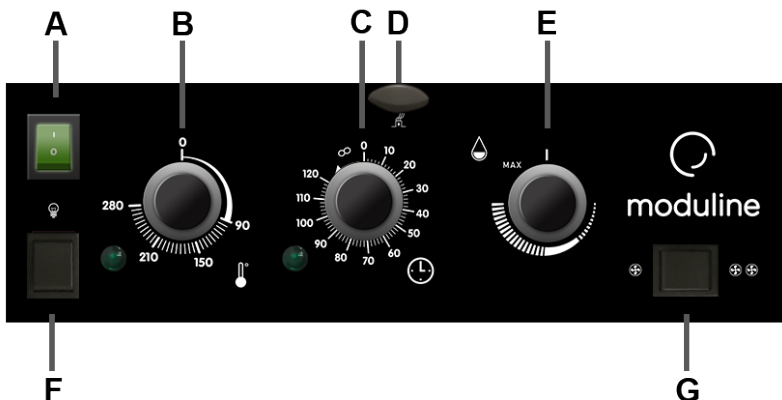

- A ON/OFF switch
- B Cavity temperature knob
- C Time setting knob
- D Knob opening/closing exhaust vent
- E Cavity humidity control knob
- F Switch Light
- G Switch double speed

MODULINESRL

Via dell'Industria 11, Z.I. San Giacomo di Veglia 31029 Vittorio Veneto (TV) - ITALY
tel. +39 0438 5063 - fax +39 0438 912 323 - info@moduline.it - www.moduline.it