

# Tiziano

## OVEN

Use and maintenance manual



TZ 230

TZ 420

TZ 425

TZ 430

TZ 435





We congratulate you for choosing a product designed and manufactured with cutting-edge technology.

The oven is checked and tested in the Manufacturer's plant before being delivered to the customer.

The "production process check sheet" enclosed with it guarantees that **each** step in the production process, from assembly to packaging, was carefully checked from both the operating and safety standpoints.

Before the installation, read the content of this manual **carefully**: it contains important information regarding product assembly and safety regulations.

## The foundation

Our company was founded in 1963 by the Lorenzo, Luigi and Paolo Cuppone brothers. It immediately specialized in the production of ovens and equipment to prepare and cook pizza. The constant research and experimentation of new equipment that are even now the strength of our company, have led us to design and patent the machinery and ovens that have revolutionized the way pizza is made.

## Technical service

Your Dealer can solve any technical problem regarding use and maintenance.

Do not hesitate to contact him in case of doubt.

CUPPONE 1963  
Cuppone F.lli S.r.l.  
Via Sile, 36  
31057 Silea (TV) - ITALY  
T +39 0422 361143  
F +39 0422 360993  
info@cuppone.com - www.cuppone.com

<b>Introduction .....</b>	<b>3</b>
Technical service.....	3
<b>Safety instructions .....</b>	<b>4</b>
<b>Basic notions .....</b>	<b>6</b>
Knowing your oven .....	6
Preparing to use the oven .....	6
Some piece of advice.....	7
<b>Use .....</b>	<b>9</b>
Knowing the control panel.....	9
Use guided procedure.....	10
<b>Maintenance and cleaning .....</b>	<b>12</b>
Warnings.....	12
Oven cleaning.....	12
Replacing components.....	14
Oven downtime for prolonged periods .....	16
Disposal at end of life .....	16
Disposing of ashes and food residues .....	16
<b>Warranty.....</b>	<b>17</b>
<b>Something is not working.....</b>	<b>18</b>
What to do in case of any malfunction .....	18

# Safety instructions



- Read this guide carefully before using and maintaining the appliance, and keep it with care in an accessible place for any future consultation by the various operators.
- Moreover, the manual must always accompany the product through its life, even in case of transfer.
- Before performing any maintenance, disconnect the electricity supply.
- Unauthorised actions, tampering or modifications that do not follow the information provided in this manual can cause damages, injuries or fatal accidents and null and void the warranty.
- Use or maintenance that fail to comply with the instructions in this manual may cause damage, injury or fatal accidents.
- The serial plate provides important technical information. This is vital in case of a request for maintenance or repair of the equipment: please do not remove, damage or modify it.
- Some parts of the equipment can reach high temperatures. We recommend you avoid pressing surfaces and do not get materials either flammable or sensitive to heat near the appliance.
- Do not rest objects on the oven, above all if built in material sensitive to heat.
- These appliances are intended to be used for commercial applications, for example in restaurant kitchens, canteens, hospitals and commercial companies such as bakeries, butcher shops, etc., but not for the continuous and mass production of food. A use other than the stated one is considered improper, potentially dangerous for people and animals and might permanently damage the appliance. The improper use of the equipment shall void the warranty.
- This appliance can be used by children aged from 8 years and above and persons with reduced physical, sensory or mental capabilities or lack of experience and knowledge if they have been given supervision and instruction concerning use of the appliance in a safe way and understand the hazard involved. Children must not play with the appliance. Cleaning and user maintenance shall not be made by children without supervision.
- To clean the appliance, any of its components or accessories and the sub-structure DO NOT use:
  - aggressive, abrasive, powder or corrosive detergents (e.g. hydrochloric or sulphuric acid, caustic soda, etc.).
  - abrasive or sharp tools (e.g. abrasive sponges, scrapers, steel brushes, etc.);
  - steamed or pressurised water jets.
- The staff using the appliance must be professionally prepared and periodically trained on its use, as well as the safety and accident prevention regulations.
- Children must be supervised to make sure they do not play with the appliance or parts of it.
- Always use tools resistant to heat (e.g. In steel). Cooking utensils in plastic or similar material might not withstand the oven high temperatures.
- Check regularly that fumes can be discharged safely. Do not obstruct the duct for any reason.
- FIRE RISK: leave the area around the appliance free and clean from fuels. Do not store flammable materials near this appliance.
- WARNING: RISK OF EXPLOSION! It is forbidden to use the oven in environments at risk of explosion.
- WARNING: always switch off the main switch when you finish using the appliance, above all during cleaning or in cases of prolonged downtime.
- If you notice any anomaly (e.g. damaged power cable, etc.), malfunction or fault, do not use the appliance and contact a Service Centre authorized by the Manufacturer. Demand original spare parts, or the Warranty will be null and void.
- Place the emergency phone numbers in a visible location.
- WARNING: it is forbidden to place flammable solids or liquids (spirits for instance) in the cooking chamber during the operation.
- Monitor the appliance during its entire operation, do not leave dishes in the oven unattended!
- Failure to follow these regulations may cause damage or even fatal injury, subsequently invalidating the guarantee and relieving the Manufacturer of all liability.
- We recommend you have the appliance checked by an Authorized Service Centre at least once a year.

## Symbols used in the manual and on the labels applied to the machine



Indicates that caution is required when performing an operation described in a paragraph that bears this symbol. The symbol also indicates that maximum operator awareness is required in order to avoid unwanted or dangerous consequences



Reference to another chapter where the subject is dealt with in more detail.



Manufacturer's tip



Indicates that the surfaces marked with this symbol may be hot and must therefore be touched carefully



Dangerous voltage



The symbol identifies the terminals which, connected to each other, carry the various parts of a device or system to the same potential (not necessarily the earth potential)



Indicates that it is necessary to read carefully the paragraph marked with this symbol before installing, using and maintaining the equipment

The company cannot be held liable for any print or transcription errors, reserving the right to make changes where deemed suitable without prior notice.

Partial reproduction without the Manufacturer's consent is prohibited. Measurements are purely indicative and not binding.

The original language used to prepare this manual is English: the Manufacturer is not responsible for any translation/interpretation or print errors.



## Knowing your oven

### ► Fig. 1

Your oven can be used only to bake pizzas or similar dishes, such as bread or focaccia and to grill vegetables.

Its main parts are:

- A Oven smoke exhaust
- B Oven door
- C Control panel
- D Panel to access electrical components
- E Oven supply input
- F Equipotential
- G Safety thermostat reset (USA models only)
- H Circuit breaker (only USA models)

The oven can manage separately the temperature:

- of the cooking chamber;
- of the bottom.

## Preparing to use the oven

Clean the oven and any accessories accurately, both externally and internally, following the instructions in the dedicated chapter rigorously.

 **Maintenance and cleaning** - page 12.

**The first time you use the oven**, we recommend you set the “chamber” and “bottom” temperatures at **150°C / 302 °F**, for at least **8 hours, without placing any food inside**. In this first phase, because of the humidity evaporating from the insulating materials, the oven will give out unpleasant smells and fumes that will gradually disappear during the following operating cycles.

 To switch the oven on and set its parameters, refer to: **Use** - page 9

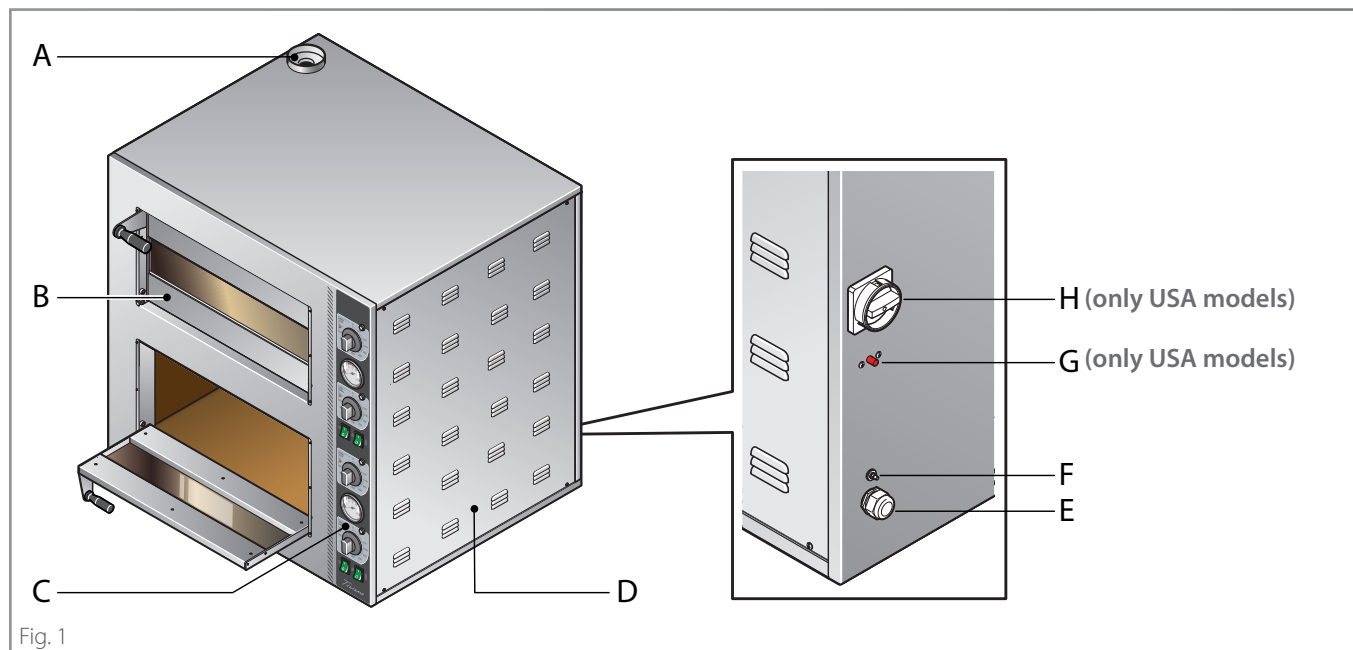

*The first day of use is considered as a running-in period: during this time the refractory bricks and insulating material keep releasing humidity until they dry out completely.*



Some parts of the equipment can reach high temperatures. We advise you to avoid touching surfaces and not to get materials either flammable or sensitive to heat near the appliance.  
Do not rest objects on the oven, above all if built in material sensitive to heat.  
Take care and use personal protection equipment (i.e. gloves) when putting food into the cooking chamber or getting it out.

## Some piece of advice...

- Before starting cooking, always preheat the oven: this is vital to get good food. Pre-heating the oven **must last at least an hour.**
- During work, keep the refractory surfaces clean using a stiff bristle brush.
- Passing from a type of pizza to another, wait for the oven to stabilize.
- An excess of flour in the cooking chamber can create smoke, smell and give the pizza an unpleasant taste.
- Clean the oven at the end of service.

### ► Fig. 2

In ovens, products cook thanks to the combined action of:

- **radiation:** the heat and infrared rays produced by the top elements make products crunchy and golden
- **convection:** the hot air that circulates in the chamber cooks the product evenly
- **conduction:** the bottom elements heat the refractory surfaces on which the products rest.

## Unsatisfactory cooking results

If the cooking results are not as expected, try and check the following:

- **incorrect oven parameters:**
  - temperature in the chamber either too high or too low
- **incorrect preheating:**
  - preheating is vital to get superb results right from the first pizza
  - during preheating, the **BOTTOM** temperature has been set too high: the refractory surfaces (without pizzas) have become too hot and burnt the first pizzas.

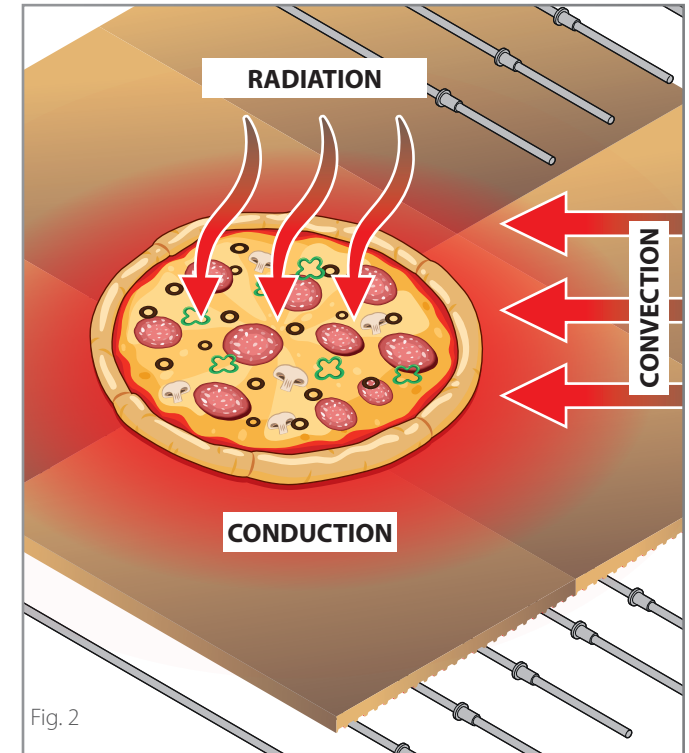

Fig. 2



## What is Pizzaform?

*Pizzaform is a manufacturer's patent. It is a special press, produced in five models, to make pizza dough discs up to Ø52cm [Ø20.47 in.].*

*Its main features are:*

- high hourly output, up to 400 pizzas an hour, without using specialized labour;
- consistent shape and thickness of the disc of dough, without giving up the traditional edge, obtained thanks to the special shape of the chrome plates;
- possibility of changing the thickness of the dough discs easily.



# Basic notions

## COOKING TABLES



The parameters in the tables are just indicative, since they can vary according to the temperature of the room where the oven is installed and the type of dough to bake (e.g. type of flour, hydration, etc.).

		 <b>Manual stretching</b>			<b>Pre-eating (manual stretching)</b>  time: 1 hour (can vary according to the set temperatures)  temperature: the same as the type of pizza to be cooked
TYPE	COOKING				
	TIME	CHAMBER TEMPERATURE	BOTTOM TEMPERATURE		
CLASSIC		3 min	<b>310°C - 330°C</b> / 590°F - 626°F	<b>150°C - 320°C</b> / 302°F - 608°F	
CLASSICA MAXI		4 min	<b>310°C - 330°C</b> / 590°F - 626°F	<b>150°C - 320°C</b> / 302°F - 608°F	
PAN		4 min	<b>330°C</b> / 626°F	<b>400°C</b> / 752°F	
BAKING-TIN		5 - 7 min	<b>330°C</b> / 626°F	<b>380°C</b> / 716°F	
PADDLE	PRECOOKING	5 min	<b>270°C</b> / 518°F	<b>260°C</b> / 500°F	
	FINISHING	3 min	<b>290°C</b> / 554°F	<b>270°C</b> / 518°F	

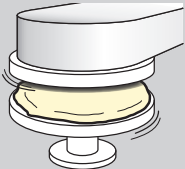
		 <b>Stretching with Pizzaform</b>			<b>Pre-heating (with Pizzaform)</b>  time: 1 hour (can vary according to the set temperatures)  temperature: the same as the type of pizza to be cooked
TYPE	COOKING				
	TIME	CHAMBER TEMPERATURE	BOTTOM TEMPERATURE		
CLASSIC		3 min	<b>310°C</b> / 590°F	<b>150°C - 300°C</b> / 302°F - 572°F	
CLASSICA MAXI		4 min	<b>310°C</b> / 590°F	<b>150°C - 300°C</b> / 302°F - 572°F	



## Table of contents

Knowing the control panel.....	9
Use guided procedure.....	10
A - Turning the oven on.....	10
B - Setting the preheating.....	10
C - Starting cooking.....	11
D - Switching the light on (optional).....	11
E - Switching the oven off.....	11



## Knowing the control panel ▶ Fig. 3

- White warning light**  
If ON, it shows the top elements are heating
- Thermostat**  
Powers the top elements and controls the temperature of the cooking chamber.
- White warning light**  
If ON, it shows the bottom elements are heating.
- Thermostat**  
Powers of the bottom elements and controls the temperature of the bottom.
- Pyrometer**  
Displays the temperature in the cooking chamber.
- Light switch**  
Switches the light in the cooking chamber on and off.
- ON/OFF switch**  
Switches the oven on and off.

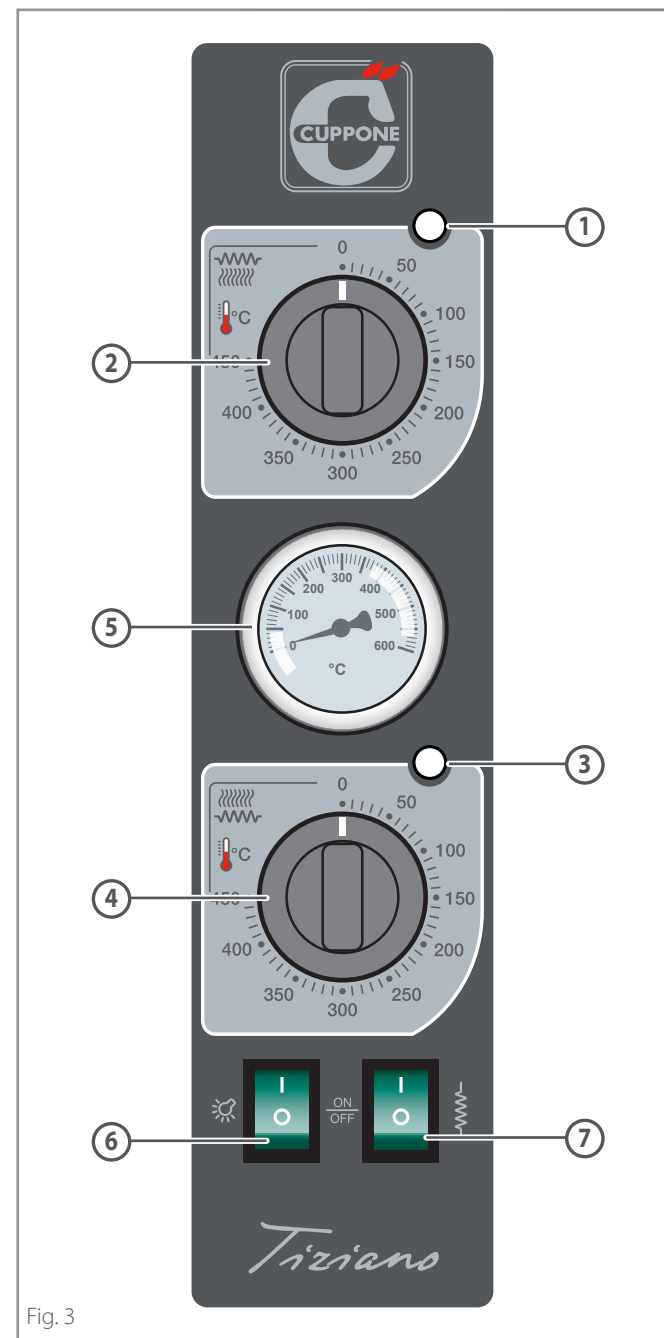

Fig. 3

## Use guided procedure

### A - Turning the oven on

#### ► Fig. 4

Pressing the **ON/OFF** key supplies the oven.

### B - Setting the preheating

#### ► Fig. 5

Rotate the **(A)** "chamber" temperature and **(B)** "bottom" temperature knobs clockwise to set the same cooking temperatures as the recipe you wish to use (see table on page 8).

After setting the temperature, the oven immediately begins to heat, however, it is necessary to wait about an hour before putting the products in the oven, so that the oven reaches an optimal temperature and is ready for cooking.

#### ► Fig. 6

The white warning lights **(C)** and **(D)** will remain on until the set temperatures are reached; their going off means that preheating is complete and the oven is ready for cooking.

The thermostats controlling the elements will keep the set temperatures constant, switching the elements on and off as required.

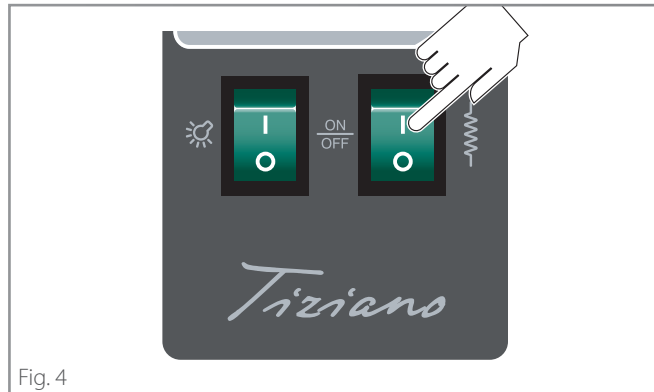

Fig. 4

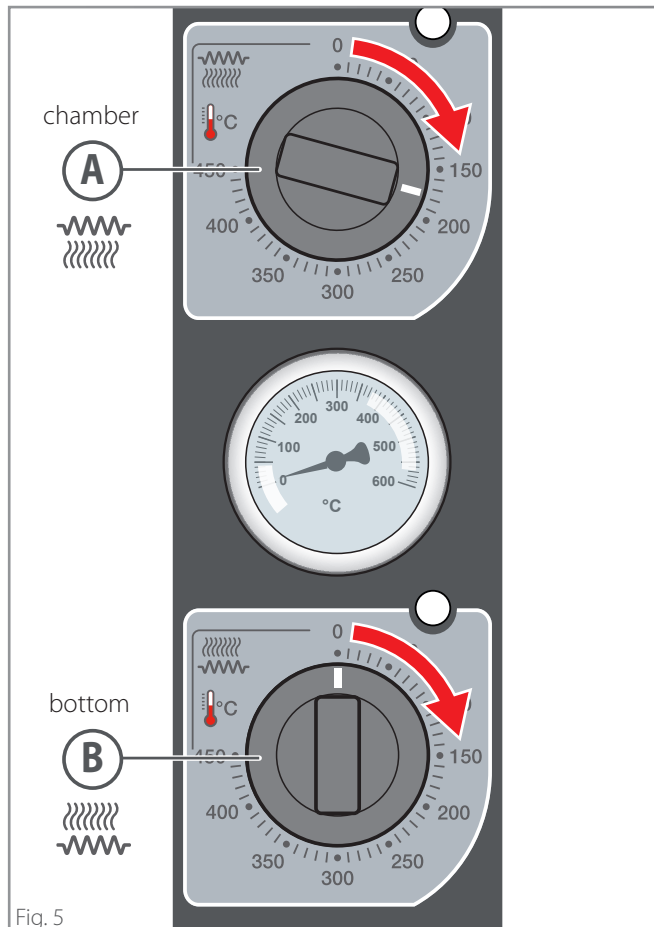

Fig. 5

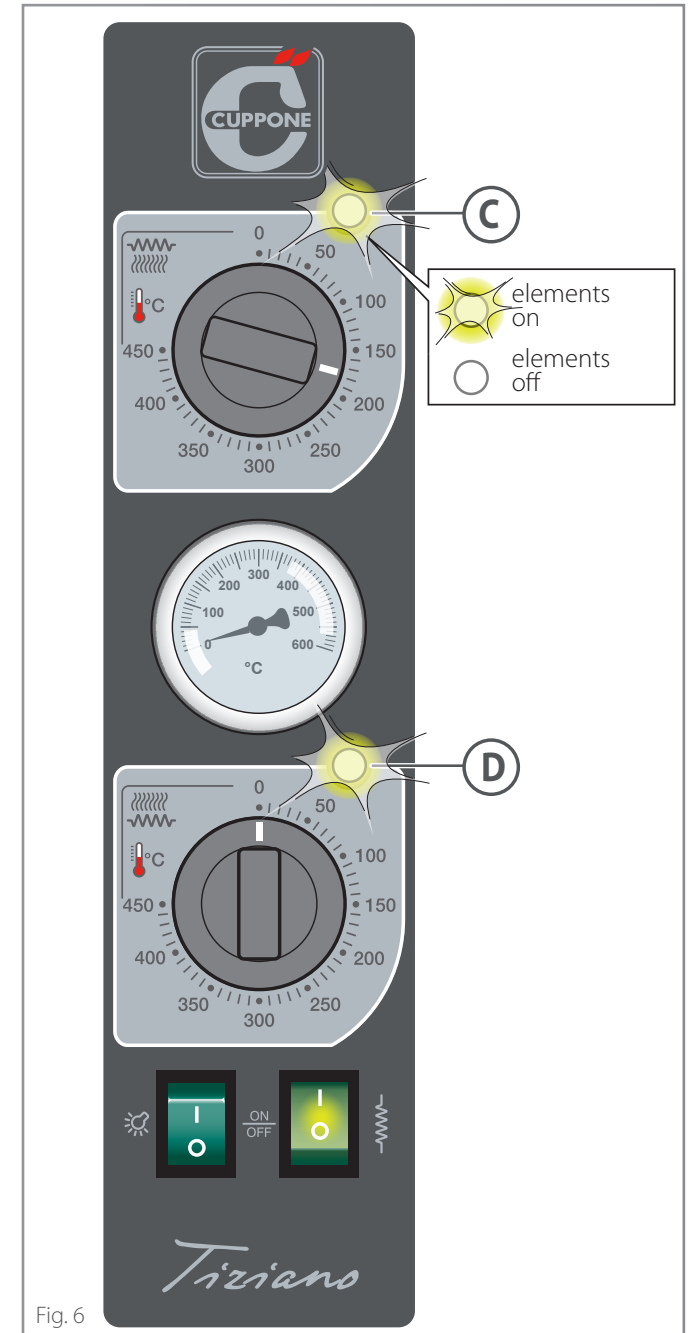

Fig. 6

## C - Starting cooking

### ► Fig. 7

Once preheating is complete, you can start cooking and bake the products using personal protection equipment (e.g. gloves) and tools suitable for contact with food and made of material resistant to high temperatures (e.g. steel).



For optimal results, always adhere to the oven capacity declared by the Manufacturer and position the products to be cooked evenly in the cooking chamber.

During cooking, it is always possible to change the temperatures acting as usual.

## D - Switching the light on (optional)

### ► Fig. 8

With the oven both off and on, the light can be switched on pressing the **light** key, as required. Press the same key to switch it off.

## E - Switching the oven off

### ► Fig. 9

To switch the oven off with the **ON/OFF** key.



Fig. 7

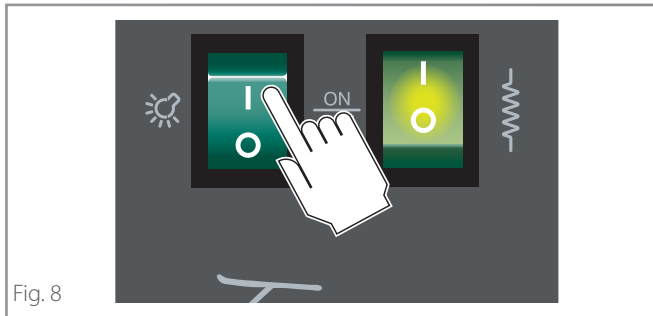

Fig. 8

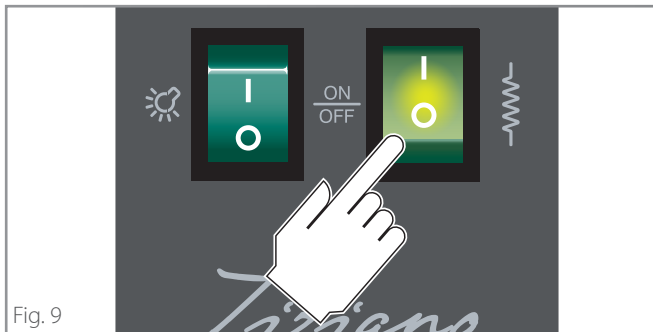





Fig. 9

## Warnings

 Before any cleaning, it is necessary to **switch off the power** to the appliance (acting on the system switch) and wear suitable personal protection equipment (e.g. gloves, etc.). The user must carry out only routine maintenance, for extraordinary maintenance, contact a Service Centre requesting service from an authorised technician. The Manufacturer warranty does not cover damages due to negligent or incorrect maintenance or cleaning (e.g. use of unsuitable detergents).

 **Any cleaning must be carried out with the oven completely cold and wearing adequate personal protection devices (e.g. gloves, etc.).**

 When cleaning any part or accessory do NOT use:

- abrasive or powder detergents;
- aggressive or corrosive detergents (e.g. hydrochloric or sulphuric acid, caustic soda, etc.). Caution! Never use these substances also when cleaning the substructure/floor under the appliance or its base;
- abrasive or sharp tools (e.g. abrasive sponges, scrapers, steel brushes, etc.);
- steamed or pressurised water jets.

 It is best to have a Service Centre perform maintenance and inspection on the appliance at least once a year to ensure top working and safety conditions.

Keep the vents of the electrical compartment clean and clear.

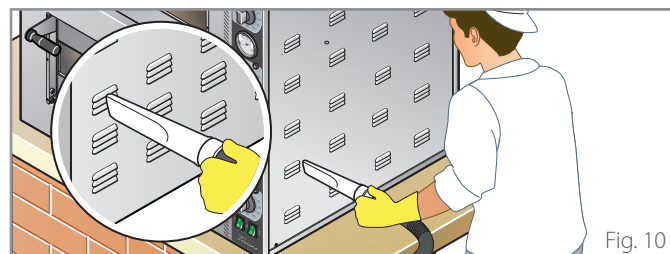

Fig. 10

## Oven cleaning

### Cleaning the external steel parts

Use a cloth dampened with hot soapy water and end with rinsing and drying.

### Cleaning the glass

Clean any glass with a soft cloth and special glass detergent.

### Cleaning the control panel

Clean the control panel with a soft cloth and a little detergent for delicate surfaces.

Avoid also using very aggressive detergents that may damage the construction material (polycarbonate).

### Cleaning the refractory surface

 *On the refractory surface, there are normally some food residues (e.g. fat, food residues, etc.) that must be removed frequently for health and safety reasons.*

Remove the coarser food residues with a natural fibre brush; then, if necessary, remove the refractory bricks of the cooking surface as shown in the figure and suck the carbonized residues accumulated under them on the bottom of the oven with an ash extraction bin.

Never use liquids to clean the refractory surface.

 While reinserting the bricks, be careful not to pinch your fingers.

 *Replacement refractory bricks can be obtained from the Manufacturer on request.*

If the use of a natural fibre brush to eliminate food residues from the refractory surface is not sufficient, see chapter "Setting the pyrolysis parameters" on page. **13**

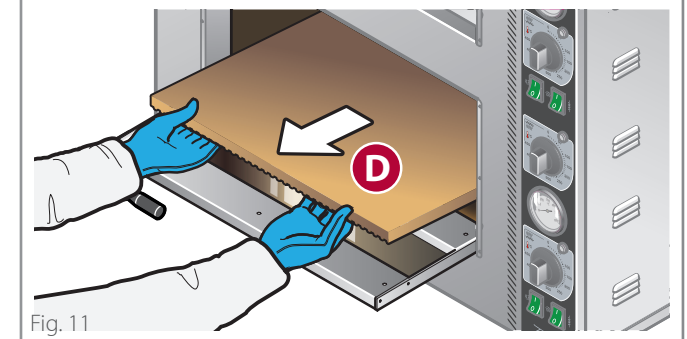
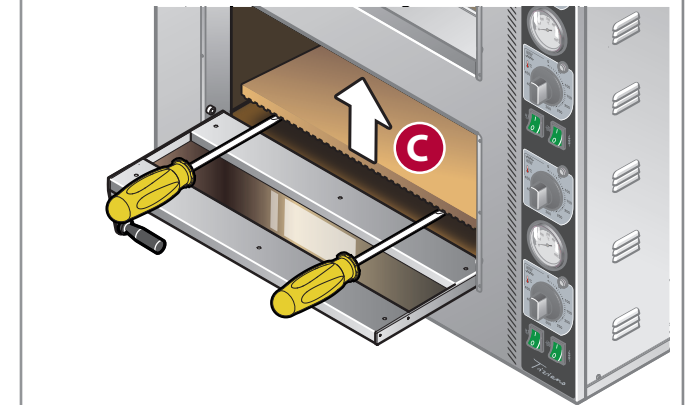
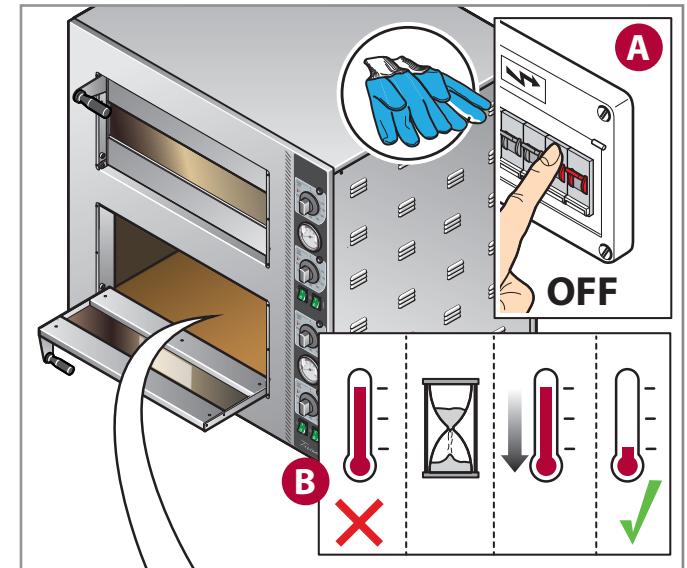



Fig. 11

## Setting the pyrolysis parameters

Pyrolysis is a thermochemical crystallization process of food residues that have deposited in the cooking chamber, which takes place by bringing the oven up to 400°.

 Before starting the pyrolysis, remove the coarser food residues with a natural fibre brush.

### ► Fig. 12

- (A)** Rotate knob **(A)** “chamber” temperature clockwise to set a temperature of **400°C / 752°F**;
- (B)** Rotate knob **(B)** “bottom” temperature clockwise to set a temperature of **400°C / 752°F**;
- (C)** switch lights **(C)** of the cooking chamber off.

### ► Fig. 13

When the set temperature is reached, switch the oven off using the **ON/OFF** key and let it cool with the door closed.

### ► Fig. 14

With a cold oven, clean the chamber from the crystallized food residues using a natural fibre brush and then vacuum with an ash extraction bin.

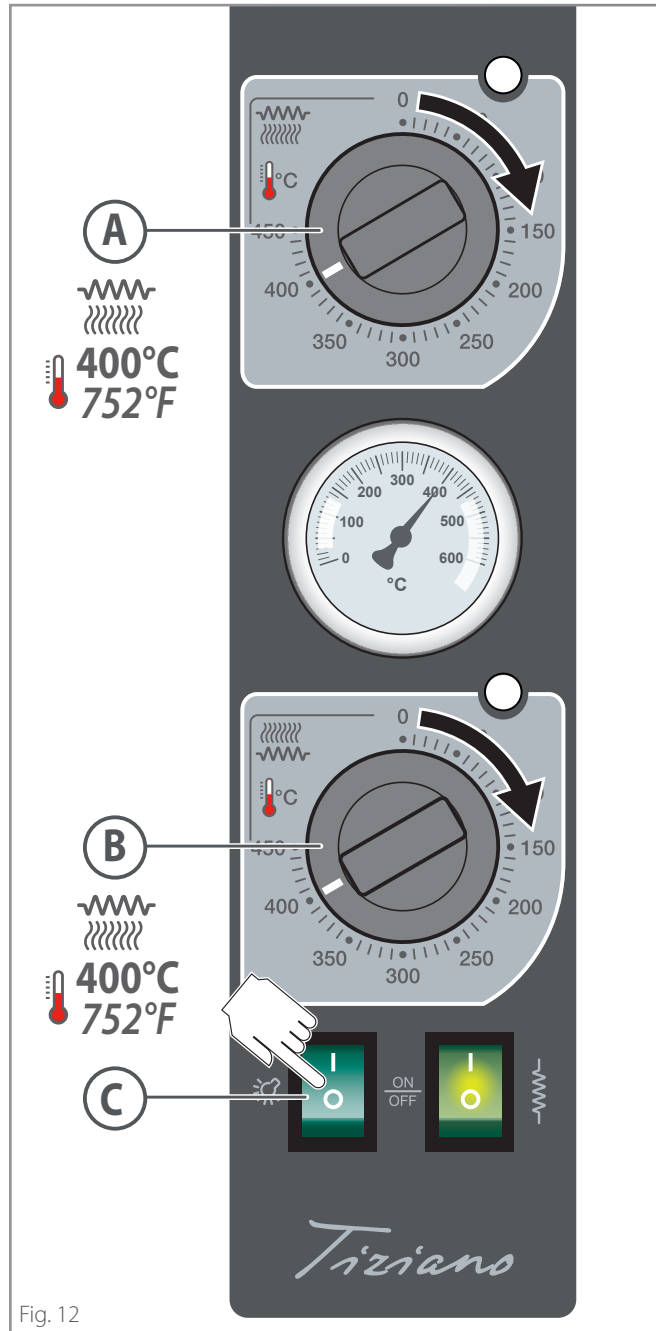

Fig. 12



Fig. 13

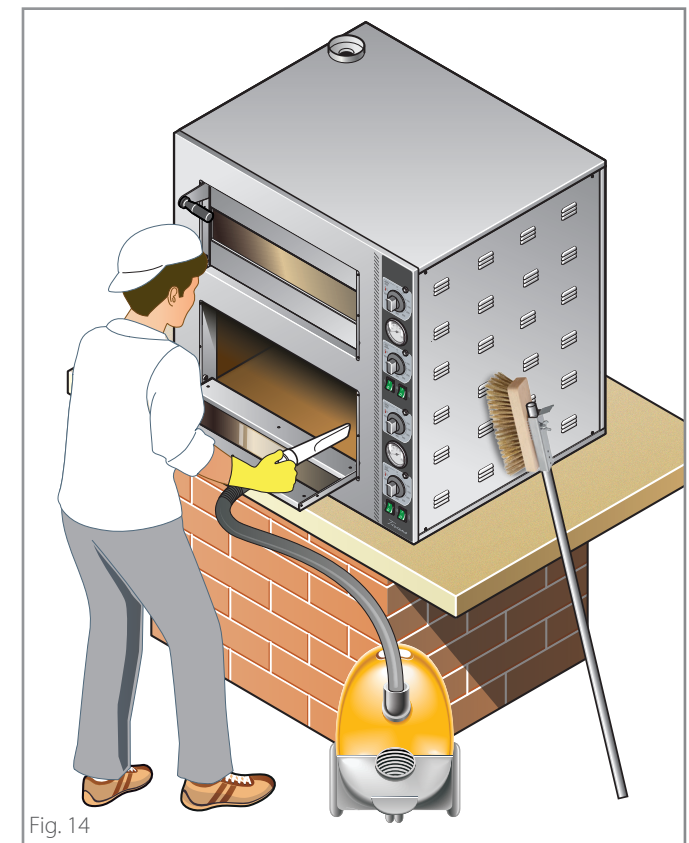





Fig. 14

## Replacing components

 The user must replace **only** the stated components: in case of a fault or for extraordinary maintenance, contact the Retailer requesting service from an authorised technician. As replacements, always use original spare parts to be requested from the Retailer: using non original parts might cause injuries to people, non optimal performance and even serious damage of the appliance itself.

 Before any replacement, it is necessary to **switch off the power** to the appliance (acting on the system switch) and wear suitable personal protection equipment (e.g. gloves, etc.).

 **Any replacement must be carried out with the oven completely cold and wearing adequate personal protection devices (e.g. gloves, etc.).**

## Replacing the door glass

► **Fig. 15**

## Replacing the internal bulb and glass

► **Fig. 16**

Before replacing the bulb, **switch off the power** to the appliance (acting on the system switch); it is not enough to use the **ON/OFF** key, because bulbs can still be live.

**Never press the bulb glass with your bare hands**; always wear gloves.

Never switch the oven on without having refitted the bulb protective glass; replace it straight away if it breaks.

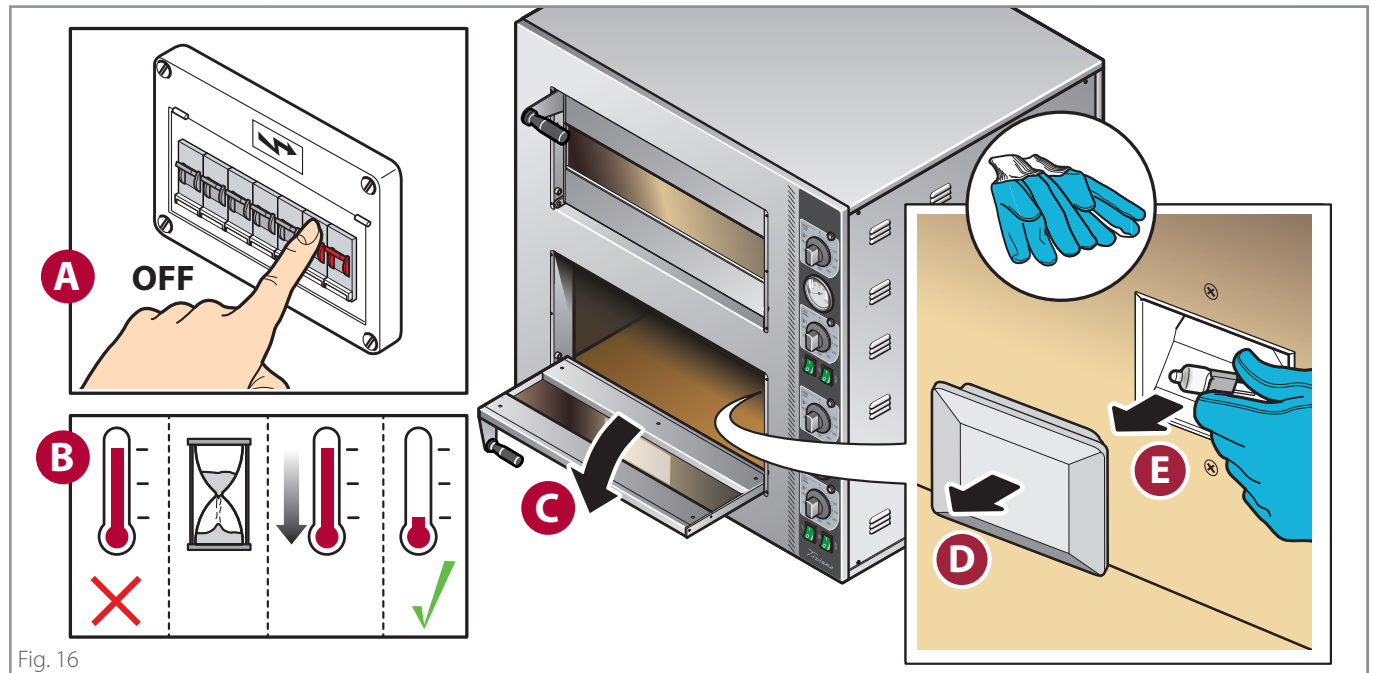
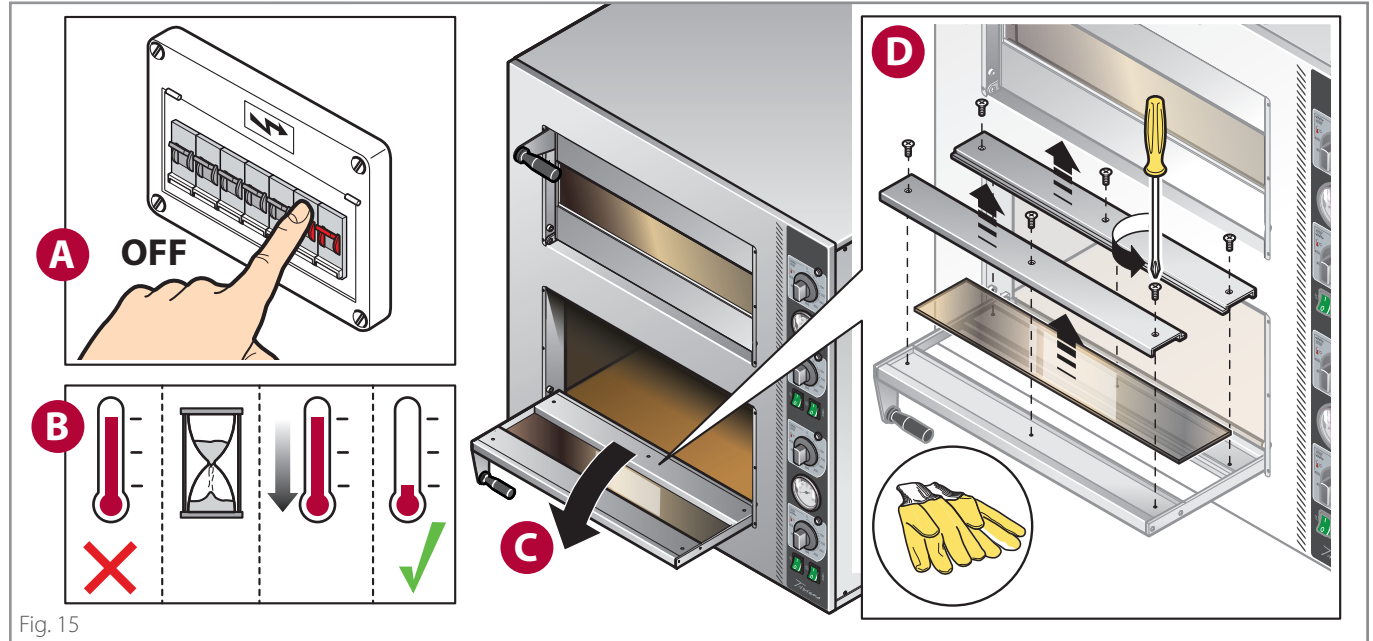

## Replacing the refractory bricks

► Fig. 17

## Replacing the door handle

► Fig. 18

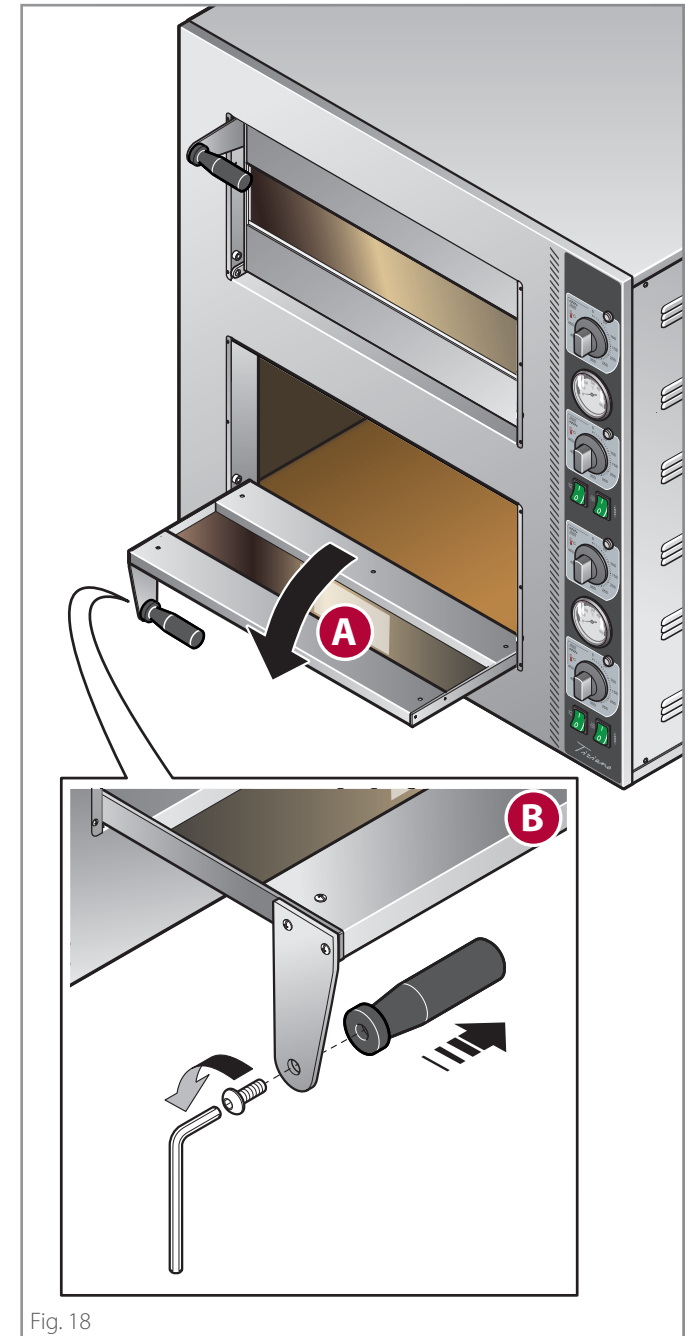
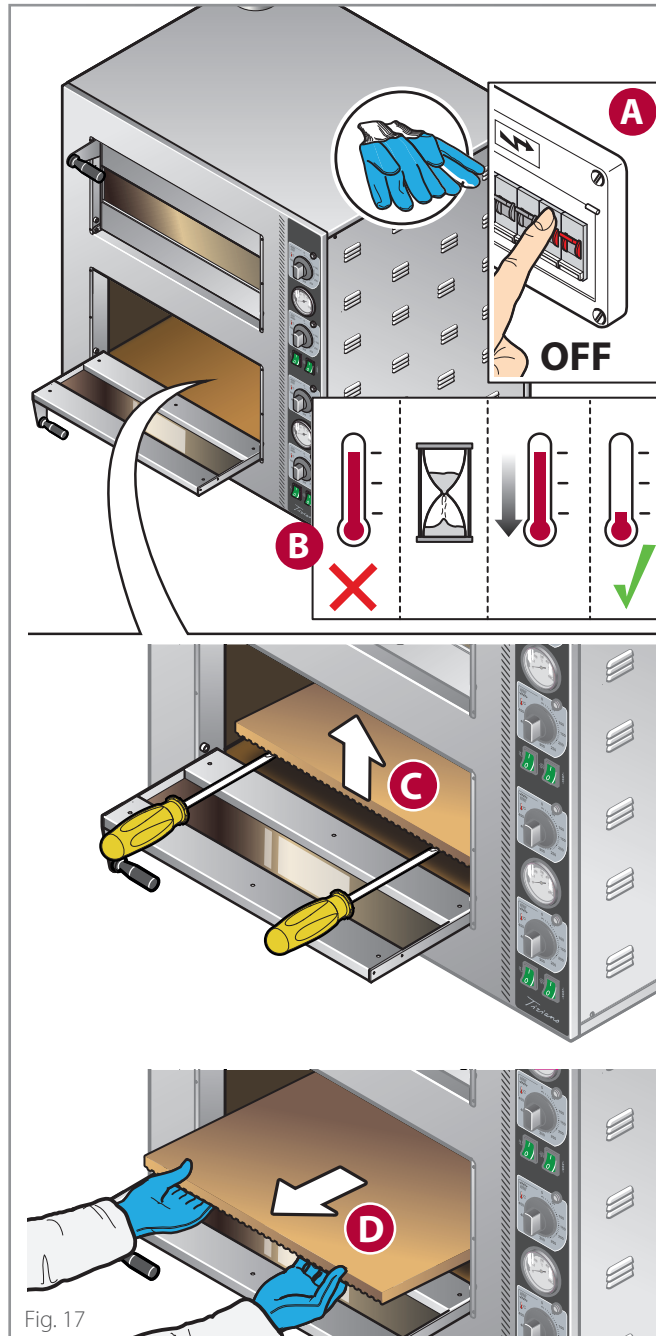

## Oven downtime for prolonged periods

During any downtime, switch the power off. Protect the steel outside surfaces passing over them with a soft cloth slightly damp with Vaseline oil.

Leave the door ajar to guarantee correct ventilation.

Before resuming operations:

- accurately clean the equipment and accessories;
- reconnect the equipment to the power;
- inspect the equipment before using it.

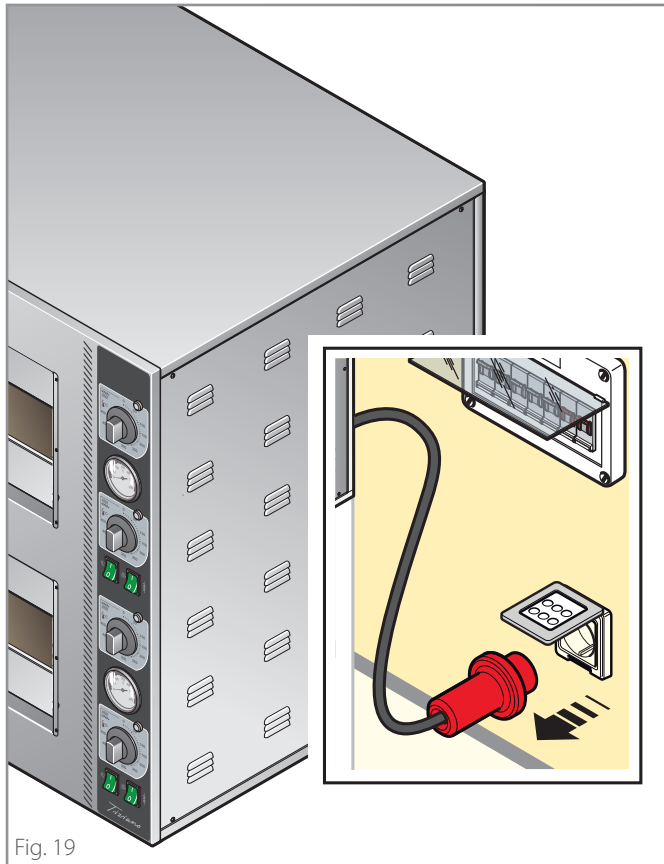

Fig. 19

## Disposal at end of life



To avoid any unauthorised use and associated risks, before discarding the machine make sure it cannot be used; for this purpose, cut and remove the power cord (once the equipment is unplugged).

Make sure no child can accidentally remain trapped inside the cooking chamber, locking the door (for example, with adhesive tape or locks).

### Equipment disposal



Pursuant to art. 13 of Legislative Decree no. 49 of 2014 "Implementation of WEEE directive 2012/19/EU on electric and electronic waste", the barred bin symbol specifies that the product was introduced on the market after August 13, 2005 and that it must not be discarded with other waste at the end of its working life but disposed of separately. All the equipment has been made with recyclable metal materials (stainless steel, iron, aluminium, zinc plate, copper, etc.) that as a percentage make up more than 90% of the weight. Attention must be paid to the management of this product at the end of its life, reducing any negative impact on the environment and improving the efficiency of resources, applying the principles of "who pollutes pays", prevention, preparation for re-use, recycling and recovery. Please remember that illicit or incorrect product disposal is punishable by law.

### Information on disposal in Italy

WEEE equipment in Italy must be delivered to:

- to Collection Centres (also named eco-islands or eco-platforms)
- the dealer where new equipment is purchased who must withdraw it free of charge ("one to one" withdrawal).

### Information on disposal in European Union countries

The EU Directives on WEEE equipment has been adopted in different ways by different countries, therefore in order to dispose of this equipment correctly we suggest that you contact your local authority or your dealer in order to ask the correct method of disposal.

## Disposing of ashes and food residues



The ash and food residues removed with cleaning must be disposed of according to the regulations in force in the country where the oven is used.

If in doubt, we suggest contacting the local authorities to ask for the correct method of disposal.

While waiting for disposal, the ash and food residues must be stored in fireproof metal cans, resistant to high temperatures and provided with a lid that must always remain closed.

Keep the latter away from the elements and in a place inaccessible to children and animals.

Do not approach materials that can be flammable, explosive or heat-sensitive.



# Warranty

- 8.1 Each Product sold is to be considered compliant when delivered in the quantity, quality and type indicated in the written Confirmation. Please refer to the provisions of art. 1.1.
- 8.2 The Seller warranties:
  - (a) that the Products are free from defects in material and workmanship, and
  - (b) that (except in the case of defects known or to be known by the Buyer) the Products are of merchantable quality.
- 8.3 Any hidden defects of the Products must be reported in writing by the Buyer within 8 days of discovery, under penalty of forfeiture. Packaging defects are excluded - even if they have caused defects or damage to the internal Products; in fact, packaging defects have to be reported at the time of delivery, pursuant to art. 5.8 of the present General Conditions of Sale.
- Written notices by the Buyer for the Products defective shall contain a full description of the defects and faults as well as the mention of the delivery date and that of defect discovery of the Products.
- Warranty is excluded if the defect derives from the Buyer's actions, such as (and not limited to) incorrect installation of the Product, use of the Product in a manner that does not comply with the normal method of use, failure to comply with the instructions contained in the "user and installation manual", tampering with the Product. Warranty does not cover normal wear and tear of the Product due to use.
- The seller is responsible for defects that occur within one year from the activation of the warranty as provided for in art. 8.12 of the present General Conditions of Sale.
- 8.4 The Seller shall have the right to examine, or have a representative examine, the defective Product and, should the existence of the defect be ascertained, the Buyer shall be entitled to repair or replacement, at the sole final decision of the Seller.
- Once the defect is reported, the Buyer must not use the Product until it is examined by the Seller or by their deputy. In case the Seller realises that the Product was used after the notification of the complaint, the Buyer loses the right to obtain replacement or repair.
- 8.5 Replacement or repair will take place under the following terms:
  - a) The Seller may repair the defective Products by going - or sending a deputy - to the place where such Products are located;
  - b) Alternatively, the Seller may repair the defective Product at its own factory, or other place chosen by the Seller;
  - c) Or alternatively, the Seller may opt for the replacement of the defective Products.
- In case the repair / replacement of the Products is not possible, the Seller will pay the Buyer a refund. Such refund shall be subjected to quantification, yet must not exceed the price paid for the Products. Any compensation for damage is excluded.
- 8.6 In case of repair of the Products at a place chosen by the Seller or in case of replacement of the defective Products, the shipment of the Product will be charged to the Buyer who must send them, at his own expense and risk, to the place indicated by the Seller.
- 8.7 In no case shall the Seller be held liable for any indirect or consequential damages and/or loss of profit that the Buyer may suffer arising out of or caused by defective or faulty Products such as (but not limited to) cancellation of orders by customers, penalties for late deliveries, forfeitures or indemnifications of whatsoever nature.
- 8.8 The Seller shall indemnify and hold the Buyer harmless from any liability or prejudices arising out of defective or faulty Products, unless the alleged liability arises from any negligent act or omission by the Buyer or any failure by the Buyer to perform its obligations.
- 8.9 The Seller shall not be liable for damage to persons and / or property that may derive from improper use of the Products and / or from any use, processing or transformation of the Products that do not comply with their intended use and / or with the instructions provided by the Seller, except the case of gross negligence or wilful misconduct by the Seller.
- The Seller will also not be liable in the event of damage to persons or property or in the case of malfunction or damage or deterioration of the Product deriving from the fact that the Product has been connected to a non-compliant electrical system.
- 8.10 The Buyer shall not be able to raise any claim for personal injury or damage to property other than those which are the subject of the contract, or for loss of profit, unless it is clear from the circumstances of the case that the Seller committed "gross negligence".
- 8.11 "Gross negligence" shall not include any and all lack of adequate care and expertise, but it is to be intended as an act or omission by the Seller which implies either a failure to consider any serious risk that a conscientious supplier would

normally have foreseen as likely to occur, or a deliberate neglect of any risk deriving from such act or omission.

- 8.12 The validity of the Warranty hereto referred is subject to activation on the website [www.cuppone.com](http://www.cuppone.com) within 48 hours after the time the Product is installed.

## Spare parts

- 9.1 Until and within 10 years as of the delivery of the Product, the Seller undertakes to assist the Buyer in identifying the spare parts for the maintenance of the Product (if it is so requested by the Buyer). In any case, the Seller is in no way responsible for the failure to identify such sources.

## Applicable law and multi-step clause

- 11.1 The Italian law, as the law of the Seller, shall govern the sale under the present Terms and Conditions of sale.
- 11.2 Both the Seller and the Buyer exclude the application of the Vienna Convention.
- 11.3 The parties shall defer the disputes arising out of the present contract to a mediation attempt managed by the Service of Mediation of the Chamber of Arbitration of Milan.
- If the mediation attempt fails, all disputes - included those of not contractual nature - arising out of, related or connected to the present General Conditions of Sale shall be settled by arbitration under the Rules of the Chamber of Arbitration of Milan (the Rules), by a sole arbitrator / three arbitrators, appointed in accordance with the Rules, which are deemed to be incorporated by reference into this clause. The Arbitral Tribunal will judge according to the Italian law. The seat of the arbitration will be in Milan (Italy). The language of the arbitration will be Italian.

# Something is not working...

## What to do in case of any malfunction

- Try and check the table on this page. If none of the proposed solutions solves the problem, continue reading the following procedure.

- Note the oven data (rating plate) and the date and number of the appliance purchase invoice.

Serial number.....

Model.....

Invoice date.....

Invoice number.....

- Read the chapter on warranty carefully.

 **Warranty** - page 17.

- Contact the Dealer with the details of the oven. While waiting for Technical service, disconnect the appliance from the mains.

### CUPPONE 1963

Cuppone F.lli S.r.l.

Via Sile, 36

31057 Silea (TV) - ITALY

T +39 0422 361143

F +39 0422 360993

info@cuppone.com - www.cuppone.com

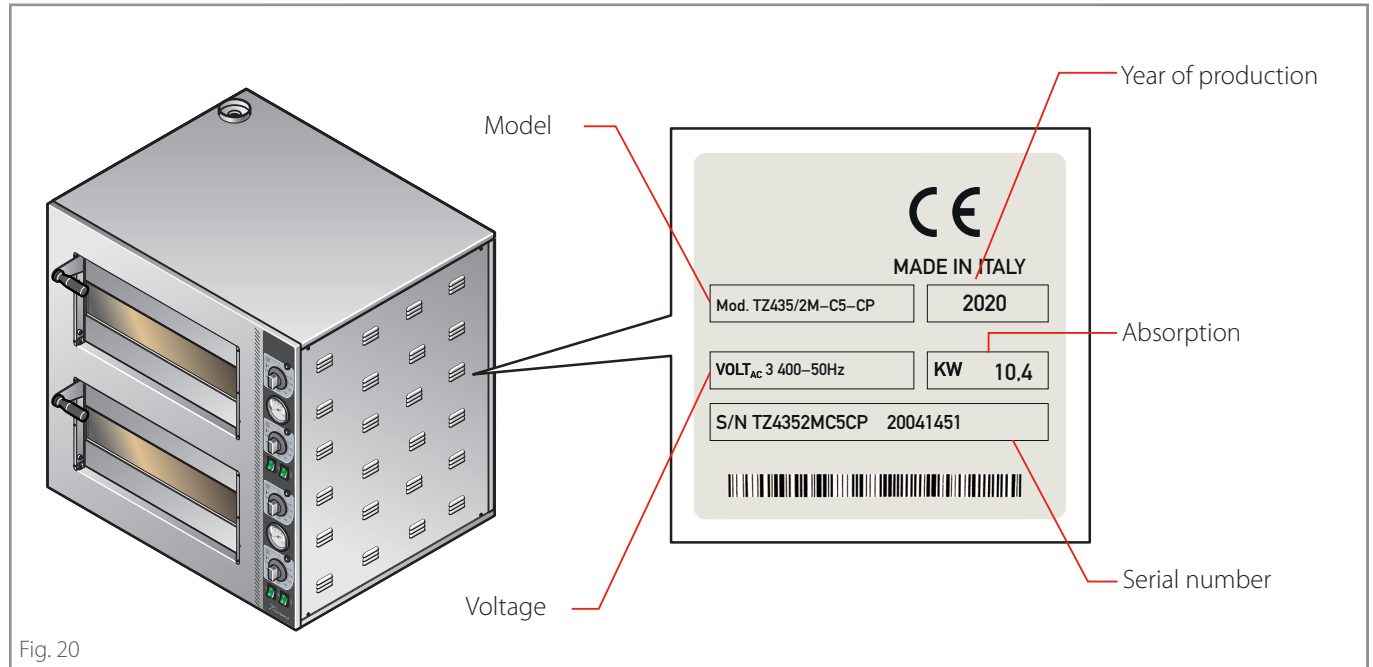

Fig. 20

Problem	Solution
The oven does not turn on	<ul style="list-style-type: none"> <li>• Make sure the oven is correctly connected to the mains (plug correctly inserted into the socket) and that the mains are working.</li> <li>• Make sure the main switch is ON.</li> </ul>
The oven turns on but cooking does not start	<ul style="list-style-type: none"> <li>• Make sure you set the cooking parameters correctly.</li> </ul>
The oven does not cook evenly	<ul style="list-style-type: none"> <li>• Make sure you set the cooking parameters correctly.</li> <li>• In case of incomplete baking cycles, change the positions of the pizzas.</li> </ul>
The first pizzas are burnt	<ul style="list-style-type: none"> <li>• During preheating, the BOTTOM temperature has been set too high: the refractory surfaces (without pizzas) have become too hot and burnt the first pizzas.</li> </ul>





## CUPPONE 1963

Cuppone F.lli S.r.l.

Via Sile, 36

31057 Silea (TV) - ITALY

T +39 0422 361143

F +39 0422 360993

info@cuppone.com - www.cuppone.com

