



Bean to Cup Coffee Machine

Instruction manual



Model • Model • Modèle • Modell • Modello • Modelo
GM948

Safety Instructions



Read carefully and keep for future reference. When transferring the appliance to someone else, ensure the manual is delivered at the same time. This appliance must only be used in accordance with these instructions and by persons competent to do so.

Before use, please confirm that all installation, setup and trial operations have been completed. Buffalo is not liable for any personal injury or property damage due to improper use of the appliance. Follow all instructions, safety precautions and warnings.

	An act that must be banned, otherwise it may cause damage to the product or endanger the user's safety.
	Anything with this mark is related to the safe use of the product and the user's personal safety. It must be operated in strict accordance with the requirements, otherwise it may cause damage to the product or endanger the user's life.
	Anything with this mark means that the user must pay attention to, otherwise it may lead to scalds or burns.
	Anything with this mark means that the user must pay attention to, otherwise it will cause damage to the product or other losses due to improper operation.



Danger of burns

- DO NOT touch hot surfaces and beware of escaping steam or hot beverage.
- When making coffee with milk, first make sure that the milk tube is properly fixed into a milk container to prevent being burned by hot steam.



Caution: Use under the following conditions

- ONLY use purified water with this appliance.
- For indoor use only and avoid direct sunlight.
- Ensure the power cord never touches hot steam or liquids coming from the discharge outlets.



Prohibited

- It is prohibited to make a modification in any way as it may cause fire, electric shock or malfunctions.
- DO NOT use outdoors or under extremely cold conditions. Freezing up of the unit may pose a safety hazard. Ambient temperature: 5°C~35°C
- NO water ingress! DO NOT immerse in water or clean with jet/pressure washers.
- Never use accessories which are not recommended by the manufacturer. They could pose a safety risk to the user and might damage the appliance. Only use original parts and accessories.



Warning

- Position on a flat, stable surface.
- A service agent/qualified technician should carry out installation and any repairs if required. Do not remove any components on this product.
- Consult Local and National Standards to comply with the following:
 - Health and Safety at Work Legislation
 - BS EN Codes of Practice
 - Fire Precautions
 - IEE Wiring Regulations
 - Building Regulations
- No parts are dishwasher safe!
- Always switch off and disconnect the power supply to the appliance before cleaning or maintenance.
- In case of a malfunction, immediately turn off and disconnect the power supply. Never use a damaged appliance.

- This appliance can be used by persons with reduced physical, sensory or mental capabilities or lack of experience and knowledge if they have been given supervision or instruction concerning use of the appliance in a safe way and if they understand the hazards involved.
- This appliance can be used by children aged from 8 years and above if they have been given supervision or instruction concerning use of the appliance in a safe way and if they understand the hazards involved.
- Cleaning and user maintenance shall not be made by children.
- Keep the appliance and its cord out of reach of children aged less than 8 years.
- Children shall not play with the appliance.
- This appliance is intended to be used in household and similar applications such as:
 - staff kitchen areas in shops, offices and other working environments;
 - farm houses;
 - by clients in hotels, motels and other residential type environments;
 - bed and breakfast type environments.
- Keep all packaging away from children. Dispose of the packaging in accordance to the regulations of local authorities.
- If the power cord is damaged, it must be replaced by a Buffalo agent or a recommended qualified technician in order to avoid a hazard.
- Buffalo recommend that this appliance should be periodically tested (at least annually) by a Competent Person. Testing should include, but not be limited to: Visual Inspection, Polarity Test, Earth Continuity, Insulation Continuity and Functional Testing.
- Buffalo recommend that this appliance is connected to a circuit protected by an appropriate RCD (Residual Current Device).

Introduction

This appliance is intended to make coffee, hot water and hot milk only. The manufacturer is not liable for any damage caused by any other use of the appliance.

If the appliance is not to be used for a long period (more than 3 days), while still coffee beans remaining inside, it is suggested to use them up so as to avoid dampness and possible blockage of the grinding system.

Pack Contents

The following is included:

- Coffee machine
- Instruction manual

BUFFALO prides itself on quality and service, ensuring that at the time of unpacking the contents are supplied fully functional and free of damage.

Should you find any damage as a result of transit, please contact your BUFFALO dealer immediately.

Installation



Warning

The appliance should be disconnected from the power supply during installation. The appliance should not be left unattended during use. The appliance will become hot so must be placed on a suitable heat and steam resistant surface. It is not suitable for polished wood surfaces.

Maintain a minimum distance of 30cm on the top, 6cm between the appliance and walls or other objects for ventilation.

NO water ingress. Do not place the unit where a water jet could be used.

Waste water discharge

Remove the appliance from the packaging. Make sure that all protective plastic film and plastic coatings are thoroughly removed from all surfaces.

- Waste water can be discharged via the water outlet hose on the back, or the waste water tank on the front.
- When using the waste water tank, ensure to fasten the water outlet hose first. (Tip: The instructions in the manual is based on the use of the waste water tank.)

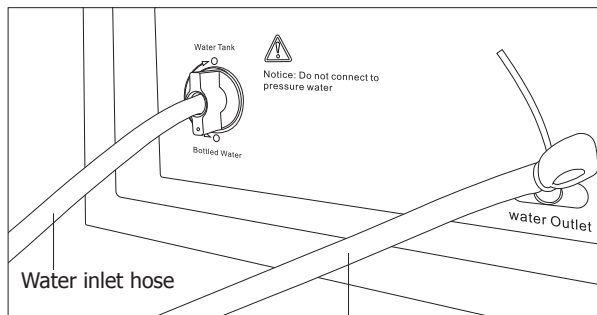

Water outlet hose

Water supply

- Bottled Water: Set the knob to the position "**Bottled Water**" and connect the water inlet hose to a full barrel.
- Water Tank: Set the knob to the position "**Water Tank**" and fasten the water inlet hose. (Tip: The instructions in the manual is based on the use of the water tank.)

Know the appliance

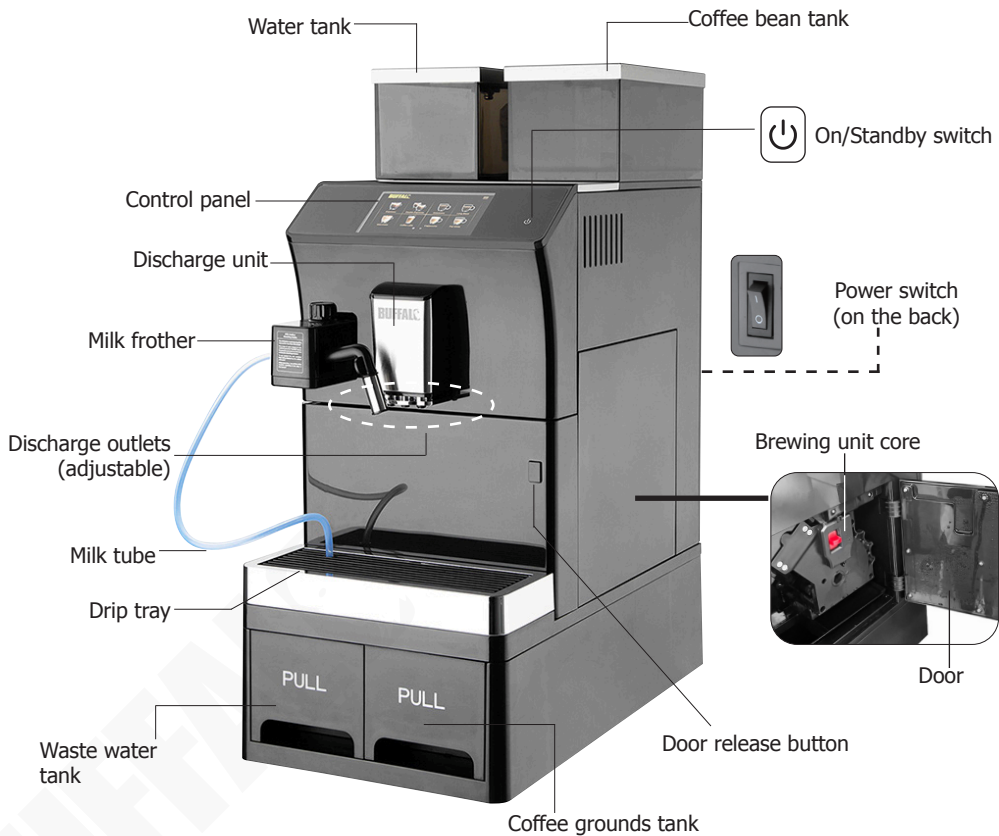

First time use

Tip: Before leaving the factory, the appliance will be tested so it is normal to have a little ground coffee in the machine. We guarantee the machine is brand new.

Buffalo recommend that the appliance is cleaned out before using for the first time, or if the appliance has been sat unused for an extended period of time. For details, refer to section "Cleaning, care & maintenance".

1. **Adding purified water:** Remove the water tank and fill to the MAX level line then put it back into the machine.

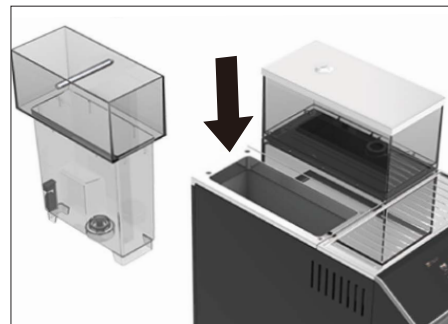

2. Locating the Brewing Unit Core:

- Press the release button to open the door.
- Check the brewing unit core has been reset to the original position (arrow pointing to the triangle point), then push inside the brewing unit core until it is clicked into place.
- Close the door.

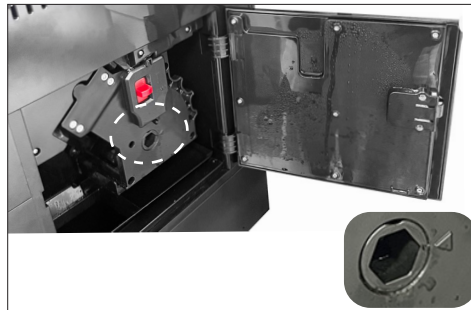

- ## 3. Locate the drip tray, waste water tank and coffee grounds tank.



- ## 4. Insert the milk frother.



To remove, press down the release button and pull out.

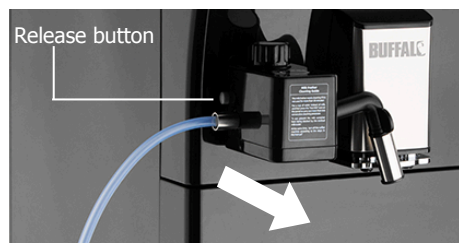

- ## 5. Add coffee beans into the coffee bean tank.
- ## 6. Place a cup under the Discharge outlets and adjust the height of the discharge outlets as needed.



7. Turning on:

- Connect the appliance to a suitable power supply.
- Set the power switch (on the back) to "I" position.
- Press  button on the front for 3 seconds. The control panel lights up then shows the welcome screen.

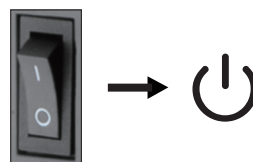

8. When the appliance is started for the first time, water filling screen will be shown.



9. The preheating screen flashes a second, then switch to rinsing screen.



10. The machine may remind you to clean the milk foam system. For details, refer to the section "Milk Foam System cleaning".
11. After the initial preheating and rinsing, the home page will be shown. The appliance is now ready for normal use.

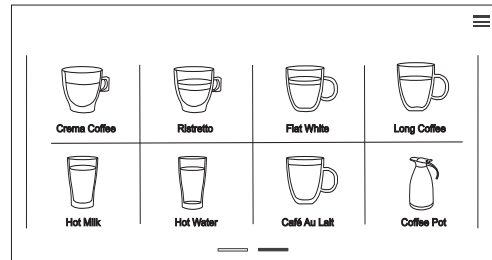
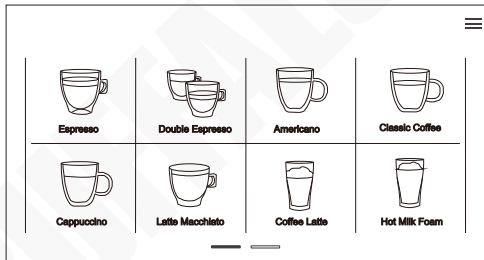

Caution

When using for the first time, the appliance may emit louder noise than normal as the water supply pipeline is empty. When the pipeline is refilled, the noise will drop. The noise level will reduce to normal after making 3 to 4 cups of coffee.



Danger of scalds

Each time the appliance is switched on, it will automatically run preheating and rinsing. This process cannot be interrupted and the machine can only be used after finishing the cycle. During preheating and rinsing, hot water will come out from the outlets then flow into the waste water tank. Take caution of the splashing hot water.

12. Turning off:

- Press  button for 3 seconds.
- The machine will run the system rinsing to clean the pipeline. (**Tip:** If coffee with milk has been made, the machine will remind you to clean the milk foam system. For details, refer to the section "Milk Foam System cleaning".)
- After system cleaning done, the control panel turns off.
- Set the power switch to "O" position. If the machine is not to be used for an extended period, disconnect it from the power supply.

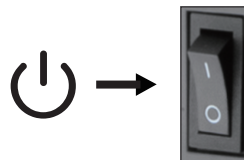

Caution

To avoid damage, DO NOT turn off the power switch before the system cleaning is completed or while the appliance is running.

Adjusting the thickness of coffee beans

The factory thickness setting is middle grade which is suitable for medium roasted coffee beans. The grinding regulator system is in the coffee bean tank. If to adjust, remove the cover first.

- If the coffee is delivered too fast or too weak, it means the grinded coffee powder is too coarse. When the grinder is running, adjust the dial counter-clockwise until the desired effect is achieved.
- If the coffee is delivered too slow or strong, it means the grinded coffee powder is too fine. When the grinder is running, adjust the dial clockwise until the desired effect is achieved.

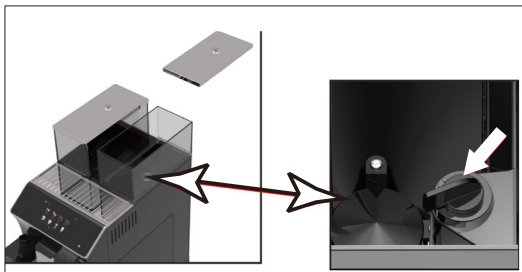



Making coffee

When in home page, press the desired beverage icon to start.

An example of making a cup of Americano:

1. Place a cup under the discharge outlets.
2. Press the "Americano" icon.
3. Coffee making starts automatically. (If desired, you can press "Stop immediately" to cancel the process.)
4. A cup of Americano will be dispensed automatically.

Tip: It is possible to amend the existing beverage setting during operation by pressing the  or  buttons. This can only be done whilst the particular element is in progress, e.g. Hot Water can only be adjusted whilst the machine is dispensing Hot Water.

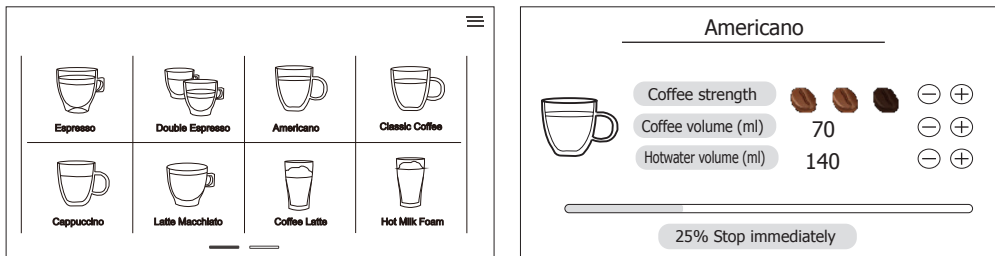

Tips for Making Hotter Coffee:

- Enter the menu page to select "Brewing Unit quick rinse" to run a cleaning cycle.
- Wash the coffee cup with hot water to make it warm (use hot water function).
- Set the coffee temperature to a higher setting.

Caution:

- If the coffee flows drop by drop, not strong enough or not rich in aroma, or too cool or hot, refer to the section "Troubleshooting" for solutions.
- During operations, various warning messages will be displayed. Refer to the section "Prompt Message" for details.

Making coffee with milk

When in home page, press the desired beverage icon to start.

An example of making Cappuccino:

1. Insert the milk tube into the fresh milk before operation.
2. Place a cup under the discharge outlets.
3. Press the "Cappuccino" icon.
4. Coffee making starts automatically. (If desired, you can press "Stop immediately" to cancel the process.)
5. A cup of Cappuccino will be dispensed automatically.

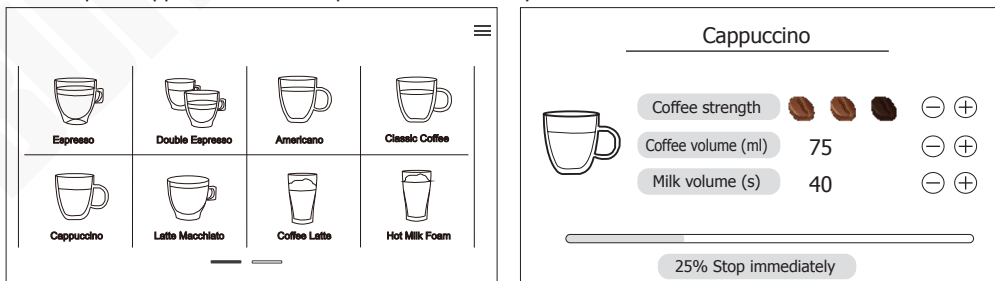

Caution:

- To make a rich milk froth, please use refrigerated whole milk (about 5°C).
- To avoid the occurrence of too much/little milk froth, after making coffee containing milk, ensure to rinse the milk froth system. For details, refer to the section "Milk Foam System Cleaning" as stated below.

Milk Foam System Cleaning

It is recommended to clean the milk foam system once operation is finished and likely to have a period of inactivity.

Warning: During cleaning, steam may come out from the outlets. Do not put your hand on the outlets to avoid burns.

1. Place a cup under the discharge outlets.
2. When in home page, press "☰" on the upper right corner to enter the Menu page. Then follow the sequence "Service menu" --> "Maintenance settings" --> "Milk Foam System steam cleaning".

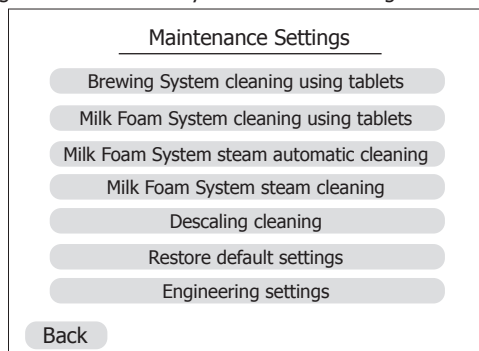
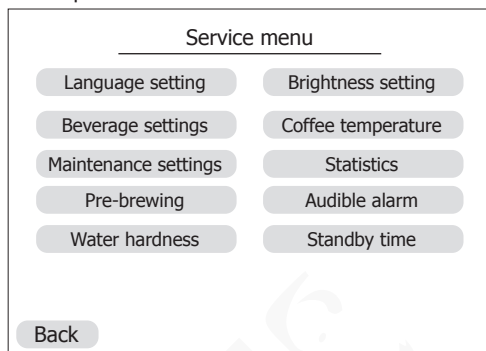

3. Press "Yes".

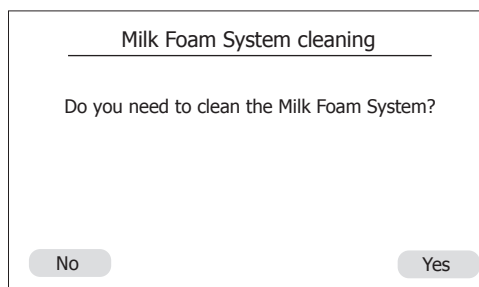

4. Add a minimum of 300ml of clean water to a container, insert the milk tube into the clean water, and press "Confirm" to proceed to the next step.
5. Please wait until the machine has finished its cleaning process.

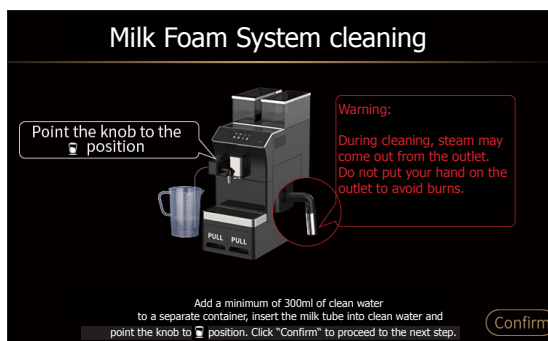

Menu setup

- When in home page, press "☰" on the upper right corner to enter the Menu page.
- Sub-menus (Brewing Unit quick rinse, Milk Foam System quick rinse, Service menu) will be shown.
- Press the desired item to set up.
- To exit, press "Back" to back to home page.

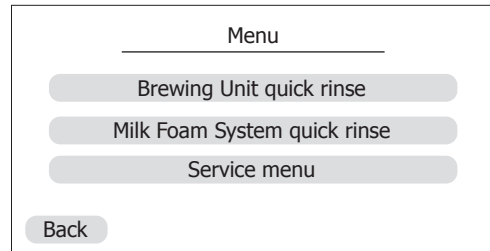

Service Menu setup

- When in Menu page, press "Service menu" to enter Service menu page. Enter the password (Initial password: 123456) and press "Confirm" to show all items under the service menu.
- Press a desired item to enter relative setup page.

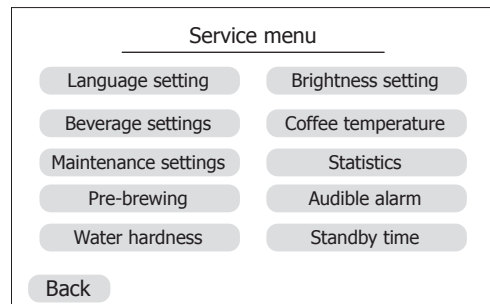
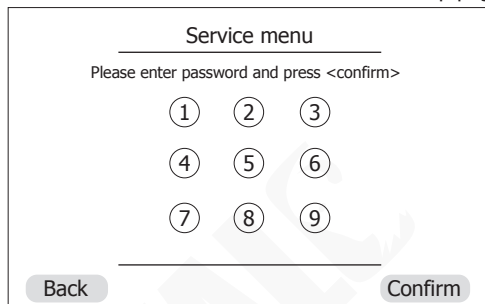

1. **Language setting:** Press > or < to select desired language (Options: English, Dutch, French, German, Italian, Spanish), then press "Confirm" to back to previous page.

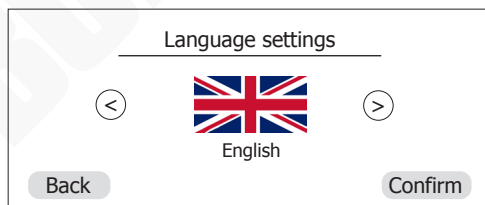

2. **Coffee pre-brewing setup:** For better tasting coffee the default setting for coffee pre-brewing is turned on. If not desired, press button in the centre of the screen. Tip: When "TURN ON" is displayed this indicates pre-brewing is switched on.

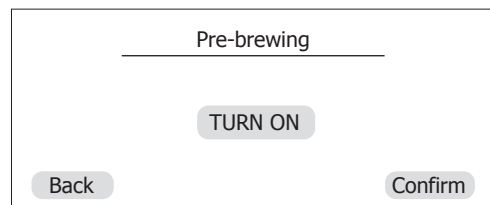

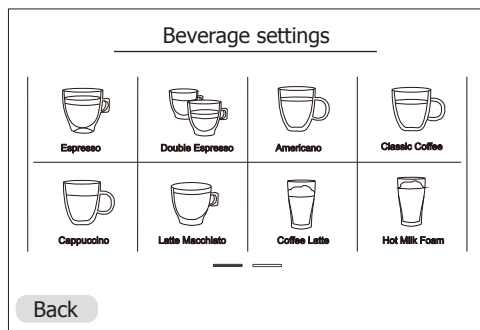
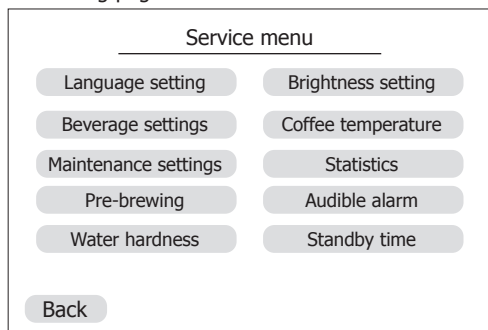

3. **Brightness setting:** Press > or < to select Brightness from 5 to 100.
4. **Coffee temperature:** Select from High, Middle, Low.
5. **Audible alarm:** When in an abnormal state, the appliance will beep and show the alarm screen. The default setting is "TURN ON". If not desired, just press the toggle button in the centre of the screen to deactivate.

6. **Water hardness:** Press > or < to select from 0 to 5 (according to the actual water hardness in your area). Tip: setting 1 is for soft water areas and setting 5 is for hardwater areas that are problematic to Limescale buildup. To prolong the lifetime of the machine we recommend keeping on setting 4 or 5.
7. **Standby time:** After an automatic cleaning, if the appliance is not to be used for a period of time (60 minutes by default), it will automatically enter standby. Options to select: none, 30min, 45min, 60min, 2h, 3h, 4h, 5h
8. **Beverage setting:** While in "Service menu" page, press "Beverage settings" to enter Beverage setting page.



Example of Americano setting:

- Press the "Americano" icon.
 - Use \ominus \oplus keys to select coffee strength, hot water volume, and coffee volume.
-  Light coffee
 Standard coffee
 Strong coffee
- Press "Confirm" to confirm all settings and back to previous page.

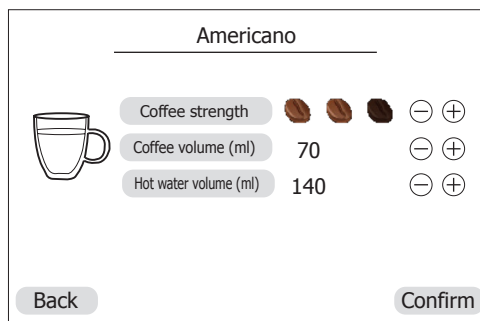

Note: For other beverages setup, please carry out similar procedures and follow the actual indications on the screen.

9. **Maintenance setting:** While in "Service menu" page, press "Maintenance settings" to enter Maintenance setting page. Press desired sub-menu to set up.

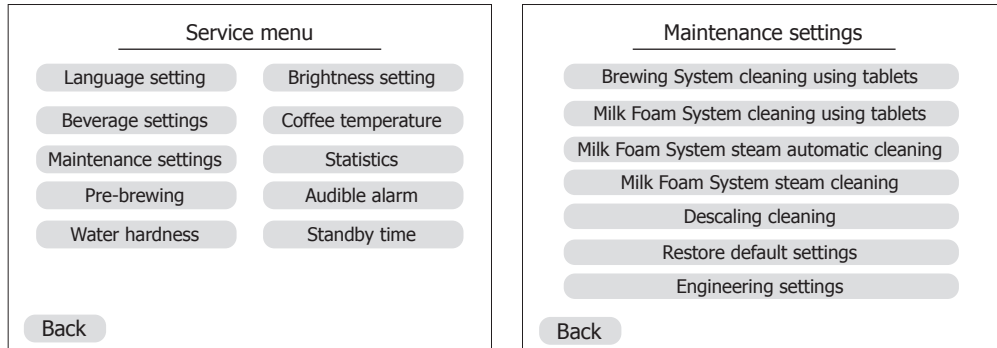

To set up the "Milk Foam System steam automatic cleaning":

The appliance is featured with an automatic cleaning to rinse the milk foam system after a set period. To set up:

- Press "Milk Foam System automatic cleaning" to enter the setup page.
- Select "30min" for example, then press "Confirm".
- The appliance will run an automatic cleaning every 30 minutes.

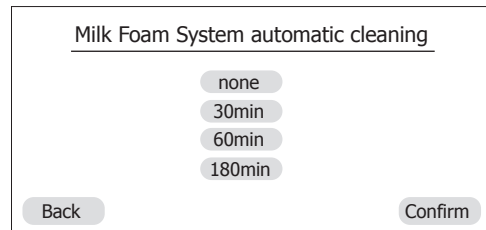

To restore default settings:

- Press "Confirm" to restore all factory settings and back to the previous page.

Caution: Be careful of the operation as it will restore all the factory default settings.

- If no need for reset, press "Back" to back to the previous page.

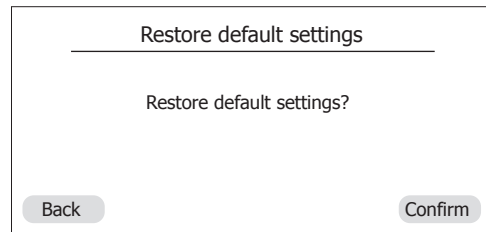

Engineering settings:



Caution: This setup is password-protected and only available to authorised maintenance staff.

10. **Statistic information:** While in "Service menu" page, press "Statistics" to check the overview of beverages produced. Press "Back" to back to the "Service menu" page.

Cleaning, Care & Maintenance



Warning: Before cleaning and maintenance, always turn off the appliance, disconnect it from the power supply, and let it cool sufficiently.

- The appliance should be cleaned regularly.
- Use warm, soapy water and a damp cloth to clean the exterior of the appliance.
- DO NOT use abrasive cleaners or pads. Never use any metal object to remove stains from the coffee machine. This can scratch the surface of the machine.
- Dry thoroughly after cleaning.

Cleaning the coffee bean tank

- Clean monthly with a soft brush to prolong the lifetime of the machine.

Cleaning the coffee grounds tank

- When the coffee grounds tank is full, the appliance will beep and the prompt message will be shown.
- Always empty and clean it in time, otherwise the appliance will fail to proceed.
- A cleaning brush can be used for thorough cleaning.
- Re-locate after cleaning.

Cleaning the waste water tank

- When the waste water tank is full, the appliance will beep and the prompt message will be shown.
- Always ensure to empty and clean it in time, otherwise water may overflow from the edge and penetrate into or around the machine, thus may damage the machine and the table surface around.
- Re-locate after cleaning.

Cleaning the inside of the appliance

- Remove the coffee grounds tank and waste water tank, then check the cleanliness of the inside.
- Coffee sediments can be removed with a brush or sponge, or alternatively with a vacuum cleaner.

Cleaning the water tank

- The water tank should be cleaned monthly to prolong the lifetime of the machine.
- Remove the water tank.
- Clean with a wet cloth and some mild detergent, then rinse under the running water.
- Fill it with purified water and insert back into the machine.

Cleaning the discharge outlets

- Wipe clean with a soft cloth or sponge. Check periodically for any blockage accumulated on the outlets, and remove immediately with a brush or toothpick.

Cleaning the brewing unit core



Danger

- **Before brewing unit cleaning, ensure to turn off the appliance first.**
- **Manually clean the unit with water only! Never use a dishwasher or any detergent.**

- The brewing unit core should be cleaned at least monthly. Press the release button to open the door then pull out the brewing unit core.
- Immerse the unit in water for about 5 minutes, then rinse thoroughly and dry well.
- Check the brewing unit core has been reset to the original position (arrow pointing to the triangle point), then push the brewing unit core inside until it is clicked into place.
- Close the door.



Descaling the water tank



Danger

- **Cleaning tablets and liquid descaler contain acidic materials irritating to eyes and skin. Ensure to strictly follow all safety warnings on the packaging to avoid injury.**
- **Take caution of the hot solution splashing out - Danger of burns!**

During descaling, ensure to follow all screen prompts and empty the waste water tray in time.

1. When in home page, press "≡" on the upper right corner to enter the Menu page. Then follow the sequence "Service menu" --> "Maintenance settings" --> "Descaling cleaning". Press "Yes".

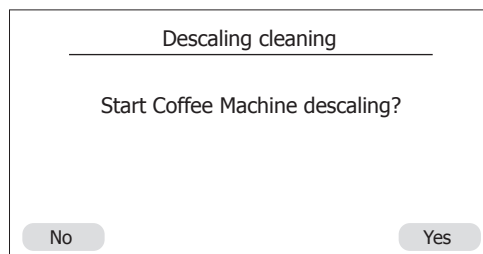

2. Make sure there is 700ml of water in the water tank and empty the waste water tank. Add the descaling agent to the water tank (Following the descalers recommended dilution rate to ensure successful descaling of the appliance.) and press "Confirm" to enter the next step. (Tip: This stage takes about 15 minutes.)

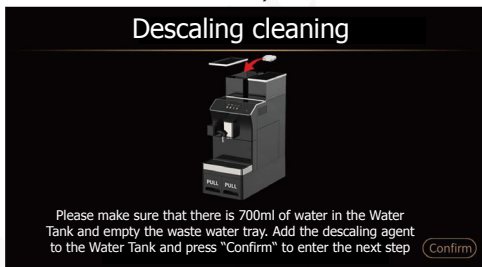

3. After cleaning the Water Tank, refill the Water Tank with greater than 1.5 Litres of water and empty the Waste Water Tray. Press "Confirm" to enter the next step. (Tip: This stage takes about 10 minutes.)

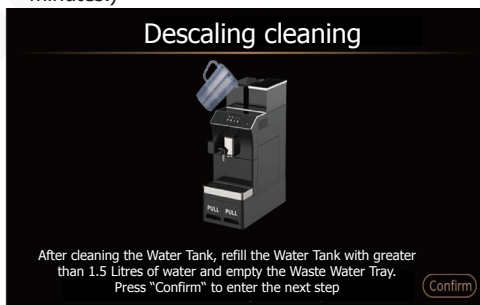

Descaling the brewing system with tablets



Cleaning tablets contain acidic materials irritating to eyes and skin. Ensure to strictly follow all safety warnings marked on the tablets' packaging to avoid personal injury.

Take caution of the hot solution splashing - Danger of burns!

During descaling, ensure to follow all screen prompts and empty the waste water tray in time.

1. When in home page, press "≡" on the upper right corner to enter the Menu page. Then follow the sequence "Service menu" --> "Maintenance settings" --> "Brewing System cleaning using tablets".
2. Press "Yes" to start. Then follow all the indications on the screen to proceed.

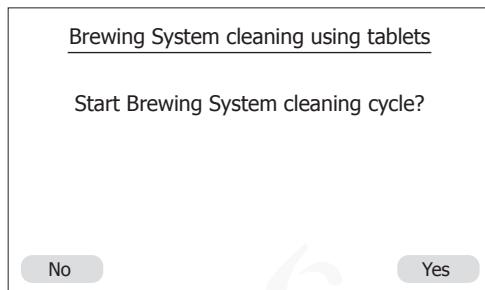

3. Remove the brewing unit, add cleaning tablets to the cavity, put it back to the original position and press "Confirm" to proceed to the next step.

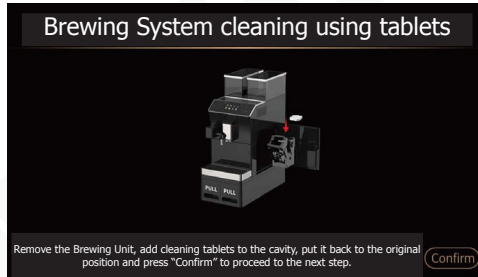

4. Wait until the cleaning process is completed. (Tip: This stage takes about 10 minutes.)

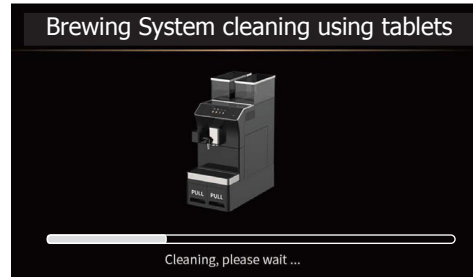

Descaling the milk foam system with tablets



Warning: During cleaning, steam may come out from the outlets. Do not put your hand on the outlets to avoid burns.
During descaling, ensure to follow all screen prompts and empty the waste water tray in time.

1. When in home page, press "≡" on the upper right corner to enter the Menu page. Then follow the sequence "Service menu" --> "Maintenance settings" --> "Milk Foam System cleaning using tablets".
2. Press "Yes" to start. Add 300ml of water and a cleaning tablet to a container, insert the milk tube into the water, and press "confirm" to proceed to the next step.

Milk Foam System cleaning using tablets

Start Milk Foam System cleaning?

No

Yes

Milk Foam System cleaning using tablets

Point the knob to the position

Warning:

During cleaning, steam may come out from the outlet. Do not put your hand on the outlet to avoid burns.

Add 300ml water and a cleaning tablet to a separate container, insert the milk tube into the cleaning solution. Point the knob to the position and click "Confirm" to proceed to the next step Confirm

3. Milk foam system cleaning in progress so please wait. After cleaning the container, add 700ml of water, insert the milk tube into the water, and press "Confirm" to proceed to the next step.

Milk Foam System cleaning using tablets



Warning:

During cleaning, steam may come out from the outlet. Do not put your hand on the outlet to avoid burns.

Milk foam system is being cleaned, please wait...

Milk Foam System cleaning using tablets



Warning:

During cleaning, steam may come out from the outlet. Do not put your hand on the outlet to avoid burns.

Rinse the container used for the cleaning solution and add 700ml of fresh water. Insert the milk tube into the clean water, point the knob to the position. Click "Confirm" to proceed to the next step Confirm

4. Wait until the cleaning is completed.

Milk Foam System cleaning using tablets



Warning:

During cleaning, steam may come out from the outlet. Do not put your hand on the outlet to avoid burns.

Cleaning, please wait...

Milk Foam System cleaning using tablets



Warning:

During cleaning, steam may come out from the outlet. Do not put your hand on the outlet to avoid burns.

Cleaning is completed

Milk foam system quick rinse

When in home page, press "≡" on the upper right corner to enter the Menu page.

- Press "Milk Foam System quick rinse" to start. Remove the Milk Tube from the Milk Container and insert it into the socket on the Waste Water Tray. Click "Confirm" to proceed to the next step.

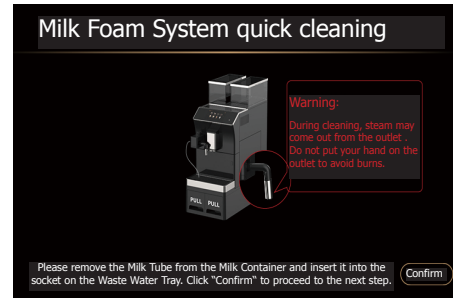
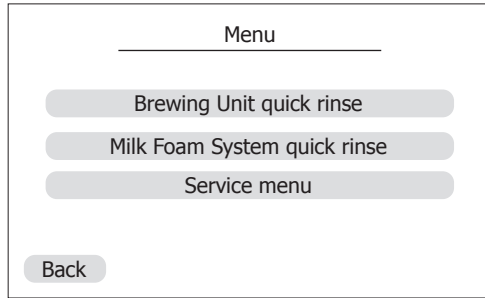

- Wait until cleaning is completed.

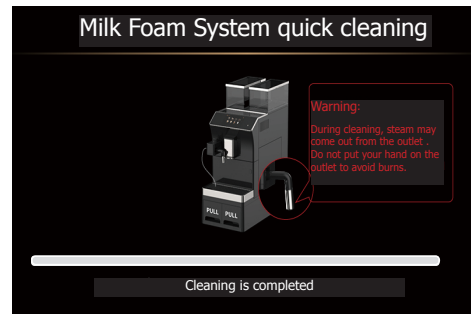
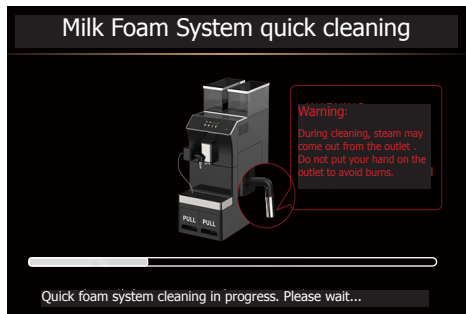

Brewing unit quick rinse



When in home page, press "≡" on the upper right corner to enter the Menu page.

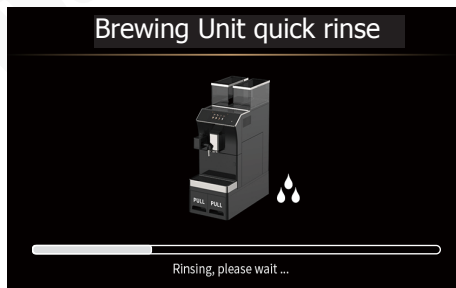



- Press "Brewing Unit quick rinse" to start. Wait until cleaning is completed.

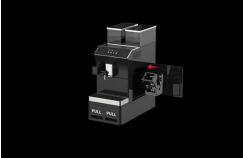





Troubleshooting

A qualified technician must carry out repairs if required.

Prompt message on display	Probable Cause	Solution
<p>Install the waste water tray</p> 	<p>Install the Waste Water Tray</p>	<p>After cleaning, the waste water tray is not put into the machine</p> <p>Put the waste water tray back into the machine</p>
<p>Insert the Brewing Unit</p> 	<p>Insert the Brewing Unit</p>	<p>After cleaning, the brewing unit core is not put into the machine</p> <p>Put the brewing unit core back into the machine</p>
<p>Please add purified water into the water tank</p> 	<p>Please add purified water into the Water Tank</p>	<p>No water in the water tank or water tank is not installed correctly</p> <p>Put the water tank in place</p>
<p>Add Coffee Bean</p> 	<p>Add coffee beans</p>	<p>Coffee bean shortage</p> <p>Add coffee beans to the bean tank</p>

Prompt message on display	Probable Cause	Solution	Solution
<p>Close the Brewing Door</p> 	Close the Brewing Door	Brewing door open	Close the brewing door
<p>Insert the Coffee Grounds Tank</p> 	Insert the Coffee Grounds Tank	After cleaning, the coffee grounds tank is not put back into the machine	Put the coffee grounds tank back to the machine
<p>Please empty the Coffee Grounds Waste Tray</p> 	Please empty the Coffee Grounds Waste Tray	Coffee grounds tank is full	Clean out the coffee grounds tank and return it to the machine
<p>NTC Error</p> 	NTC error	NTC failure	Turn off the machine, wait 30 minutes, and turn it on again. If problem persists, consult a qualified technician
<p>Drive System Error</p> 	Drive System error	Transmission system abnormal	<ol style="list-style-type: none"> 1. Open the brewing door, take out the brewing unit core, and check for the presence of any foreign object thus causing the brewing core to stick 2. Turn off the main power supply, wait a few minutes then restart the machine

Prompt message on display	Probable Cause	Solution
<p>Grinding System Error</p> 	Grinding System error	Grinding System Error
<p>Pipe Blockage</p> 	Pipe blockage	<p>Pipe blockage</p> <ol style="list-style-type: none"> 1. Adjust the grinding system to thicker powder setting 2. Clean the brewing unit system 3. If the problem persists please contact a qualified technician
<p>Coffee Boiler Power Off</p> 	Coffee Boiler power off	Coffee Boiler Power Off
<p>Steam Boiler Power Off</p> 	Steam Boiler power off	<p>Steam Boiler Power Off</p> <p>Turn off the machine, wait a few minutes, then turn on the machine again. If the problem persists please contact a qualified technician</p>

Troubleshooting

A qualified technician must carry out repairs if required.

Fault	Probable Cause	Solution
The appliance is not working	The unit is not switched on	Check the unit is plugged in correctly and switched on
	Plug or lead is damaged	Replace plug or lead
	Fuse in the plug has blown	Replace the fuse
	Mains power supply fault	Check mains power supply
Coffee does not flow from the discharge outlet, but from the surrounding area of the door	Coffee outlet blocked with dry coffee residues	Use the toothpick, sponge or a brush to clean the coffee discharge outlet
Too fast flowing of coffee	Ground coffee powder too thick	Refer to the section "Adjusting the thickness of coffee beans"
Water instead of coffee flows from the coffee outlet	Feeding pipe is blocked with coffee powder	Use a cleaning brush to clean the feeding pipe of coffee powder
Water tank shortage	No water in the water tank or water tank is not installed back	Fill the tank with purified water and return it to the machine
Coffee grounds tank is full	Coffee grounds tank needs to be emptied	Empty Coffee grounds tank and clean the coffee grounds inside, then reinstall back
Waste water tank is full	Waste water tank needs to be emptied	Remove the waste water tank and clean the waste water inside it and reinstall it into the machine
Milk foam is too large or there is milk gushing from the outlet	Milk is not cold enough or not whole milk used	Use whole milk stored in a refrigerator (at about 5°C). If the results are not satisfactory, please change the milk brand
	Foam system is blocked	Perform foam system cleaning, following the section "Milk foam system cleaning"

Technical Specifications

Note: Due to our continuous improvement process, the product specifications are subject to change without notice.

Model	Voltage	Power	Water tank Capacity	Coffee bean tank capacity	Dimensions h x w x d mm	Net Weight
GM948	220-240V~ 50/60Hz	1300W	3.5L	1kg	605 x 251 x 475	16.5kg

Electrical Wiring

This appliance is supplied with a 3 pin BS1363 plug and lead.

The plug is to be connected to a suitable mains socket.

This appliance is wired as follows:

- Live wire (coloured brown) to terminal marked L
- Neutral wire (coloured blue) to terminal marked N
- Earth wire (coloured green/yellow) to terminal marked E

This appliance must be earthed.



If in doubt consult a qualified electrician.

Electrical isolation points must be kept clear of any obstructions. In the event of any emergency disconnection being required they must be readily accessible.

Compliance

The WEEE logo on this product or its documentation indicates that the product must not be disposed of as household waste. To help prevent possible harm to human health and/or the environment, the product must be disposed of in an approved and environmentally safe recycling process. For further information on how to dispose of this product correctly, contact the product supplier, or the local authority responsible for waste disposal in your area.



BUFFALO parts have undergone strict product testing in order to comply with regulatory standards and specifications set by international, independent, and federal authorities.



BUFFALO products have been approved to carry the following symbol:

All rights reserved. No part of these instructions may be produced or transmitted in any form or by any means, electronic, mechanical, photocopying, recording or otherwise, without the prior written permission of BUFFALO. Every effort is made to ensure all details are correct at the time of going to press, however, BUFFALO reserve the right to change specifications without notice.

DECLARATION OF CONFORMITY

- Conformanceverklaring • Déclaration de conformité • Konformitätserklärung • Dichiarazione di conformità • Declaración de conformidad

Equipment Type • Uitrustingstype • Type d'équipement • Gerätetyp • Tipo di apparecchiatura • Tipo de equipo	Model • Modèle • Modell • Modello • Modelo
Bean to Cup Coffee Machine Bean to Cup Coffee Machine - 10" Colour display	GM948 (-E) GM949 (-E)
Application of Territory Legislation & Council Directives(s) Toepassing van Europese Richtlijn(en) • Application de la/des directive(s) du Conseil • Anwendbare EU-Richtlinie(n) • Applicazione delle Direttive • Aplicación de la(s) directiva(s) del consejo	<p>Low Voltage Directive (LVD) - 2014/35/EU Electrical Equipment (Safety) Regulations 2016 EN 60335-1:2012 +A11:2014 +A13:2017 +A1:2019 +A14:2019 +A2:2019 +A15:2021 EN 60335-2-15:2016 +A11:2018 +A1:2021 +A2:2021 +A12:2021 EN 62233:2008</p> <p>Electro-Magnetic Compatibility (EMC) Directive 2014/30/EU - recast of 2004/108/EC Electromagnetic Compatibility Regulations 2016 (S.I. 2016/1091) EN IEC 55014-1:2021 EN IEC 55014-2:2021 EN IEC 61000-3-2: 2019 +A1:2021 EN 61000-3-3: 2013 +A1:2019 +A2:2021</p> <p>Restriction of Hazardous Substances Directive (RoHS) 2015/863 amending Annex II to Directive 2011/65/EU Restriction of the Use of Certain Hazardous Substances in Electrical and Electronic Equipment Regulations 2012 (S.I. 2012/3032)</p>
Producer Name • Naam fabrikant • Nom du producteur • Name des Herstellers • Nome del produttore • Nombre del fabricante	Buffalo

I, the undersigned, hereby declare that the equipment specified above conforms to the above Territory Legislation, Directive(s) and Standard(s).

Ik, de ondergetekende, verklaar hierbij dat de hierboven gespecificeerde uitrusting goedgekeurd is volgens de bovenstaande Richtlijn(en) en Standaard(en).

Je soussigné, confirme la conformité de l'équipement cité dans la présente à la / aux Directive(s) et Norme(s) ci-dessus. Ich, der/die Unterzeichnende, erkläre hiermit, dass das oben angegebene Gerät der/den oben angeführten Richtlinie(n) und Norm(en) entspricht.

Il sottoscritto dichiara che l'apparecchiatura di sopra specificata è conforme alle Direttive e agli Standard sopra riportati. El abajo firmante declara por la presente que el equipo arriba especificado está en conformidad con la(s) directiva(s) y estándar(es) arriba mencionadas.

Date • Data • Date • Datum • Data • Fecha

Signature • Handtekening • Signature • Unterschrift Firma • Firma

Full Name • Volledige naam • Nom et prénom • Vollständiger Name • Nome completo • Nombre completo
Position • Functie • Fonction • Position • Qualifica • Posición

Producer Address • Adres fabrikant • Adresse du producteur • Anschrift des Herstellers • Indirizzo del produttore • Dirección del fabricante

11th Apr 2024

DocuSigned by:

Ashley Hooper

B39382C9FD9C478...

Ashley Hooper

DocuSigned by:

Eoghan Donnellan

D352874F7FAB460...

Eoghan Donnellan

Group Head of Product Quality & Compliance

Commercial Manager/ Importer

Fourth Way,
Avonmouth,
Bristol,
BS11 8TB
United Kingdom

Unit 9003,
Blarney Business Park,
Blarney,
Co. Cork
Ireland





UK	+44 (0)845 146 2887
Eire	
NL	040 – 2628080
FR	01 60 34 28 80
BE-NL	0800-29129
BE-FR	0800-29229
DE	0800 – 1860806
IT	N/A
ES	901-100 133



<http://www.buffalo-appliances.com/> 

GM948_EN_A5_v1_2024/05/28